

Crosby IP

Lifting Clamps

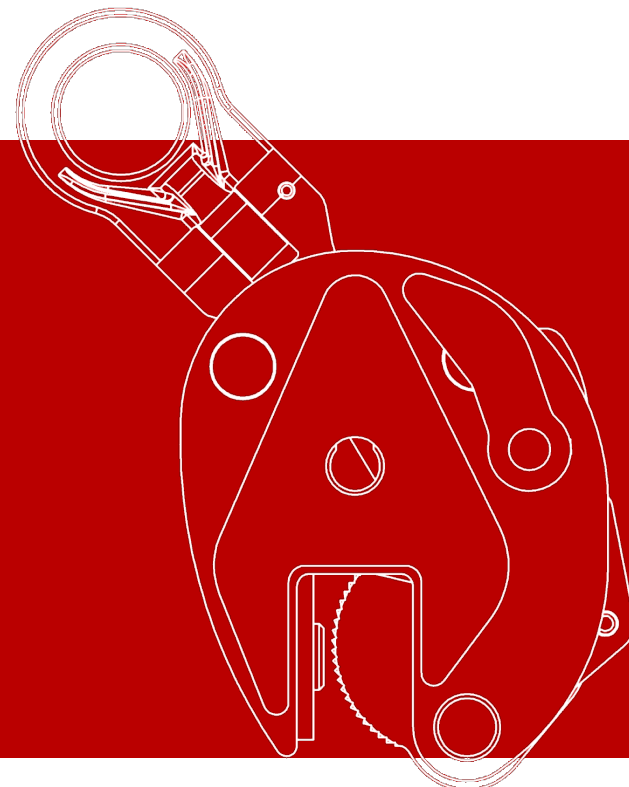

- CrosbyIP
- Definition of a lifting clamp
- Application areas
- Standard range – vertical
- Standard range – horizontal
- Standard range – miscellaneous
- Special clamps
- Competition and USP's
- Safe use of clamps

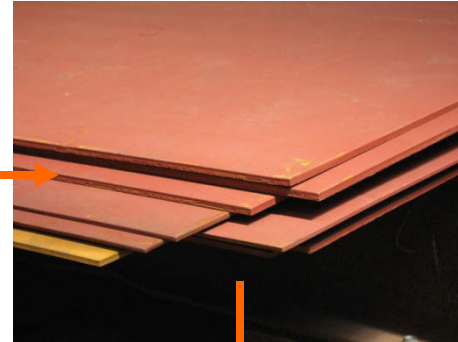

Lifting clamp - clamp; A lifting clamp is a tool designed to **lift a load**, between a pair of **claws** or clamping **jaws**, which are **pressed to the load by the weight of the load**.

Clamping principals;

Penetration

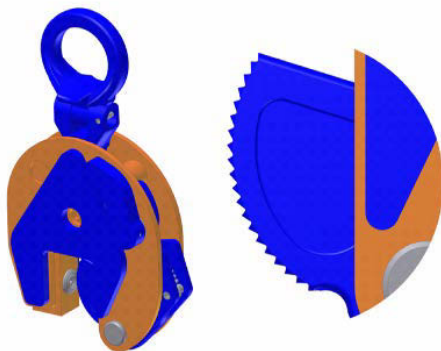

Friction

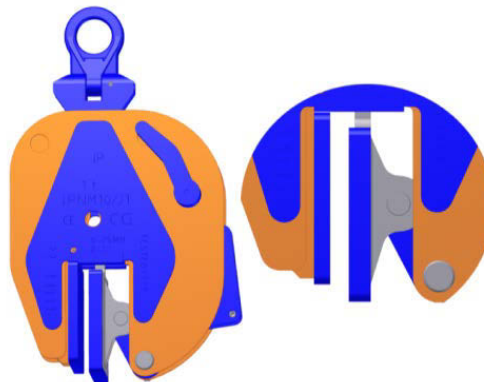

Retaining

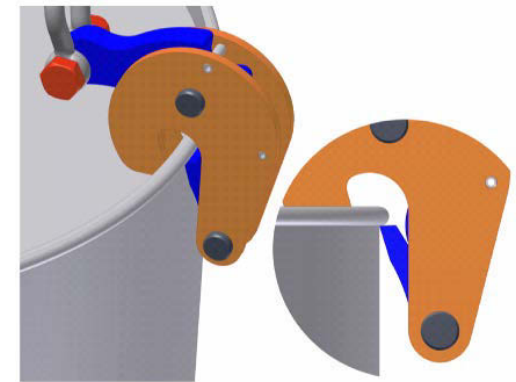

Methods of lifting

Vertical



Horizontal



Components of a lifting clamp

Load carrying components

Lifting eye

Lifting eye shaft

Body

Camsegment

Camsegment shaft

Pivot

Non Load carrying components

Latch

Spring



Components of a lifting clamp

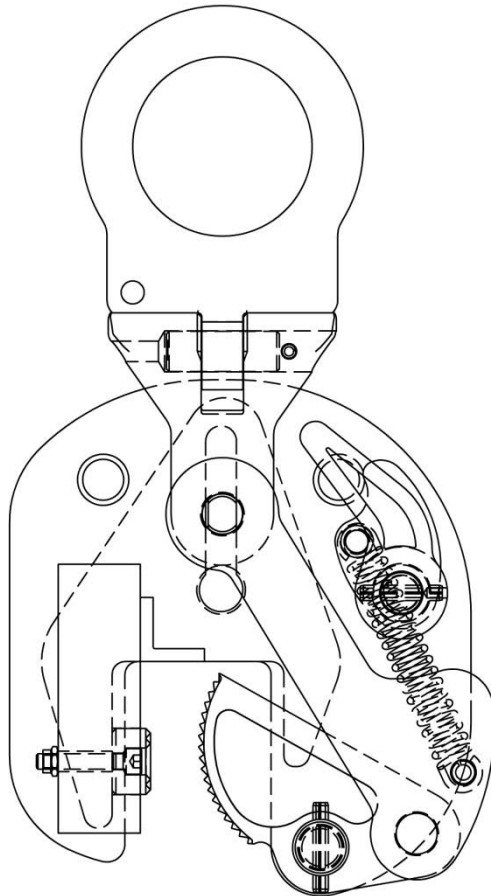

Working principle of a vertical lifting clamp

Pivoted link mechanism;

Turn lifting force into clamping force.

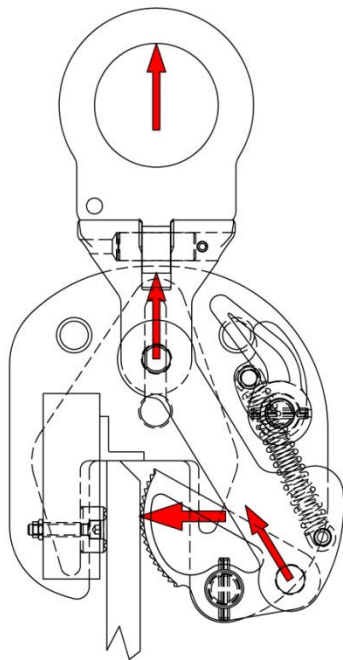

Pretension;

Clamping force without load on lifting eye.

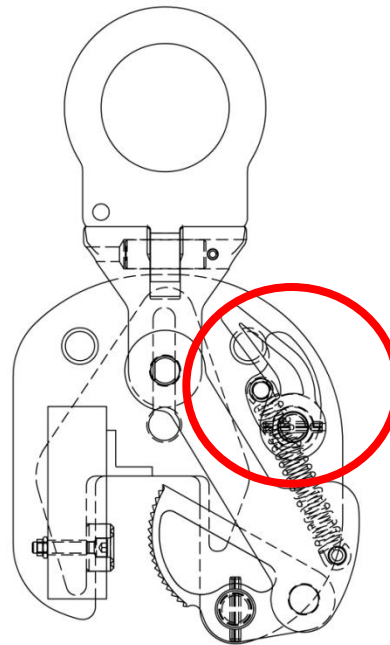

Jaw opening

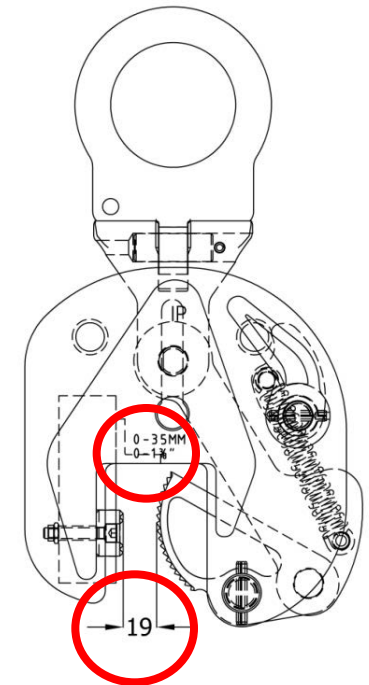

Working principle of a vertical lifting clamp

"Open" position

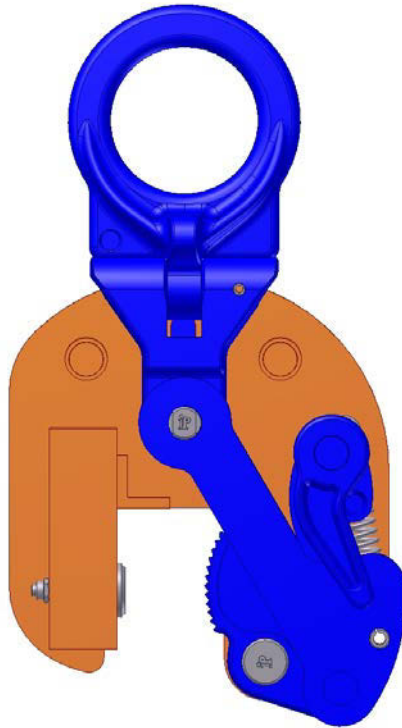

"Closed" position

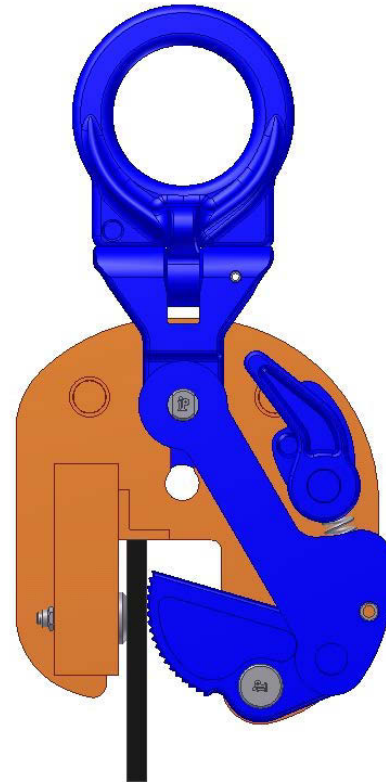

Clamping forces

$$N1 = Fk \times A : B$$

$$N2 = \frac{1}{2} 2FI \times C : B$$

$$\text{Total clamping force} = N1 + N2$$

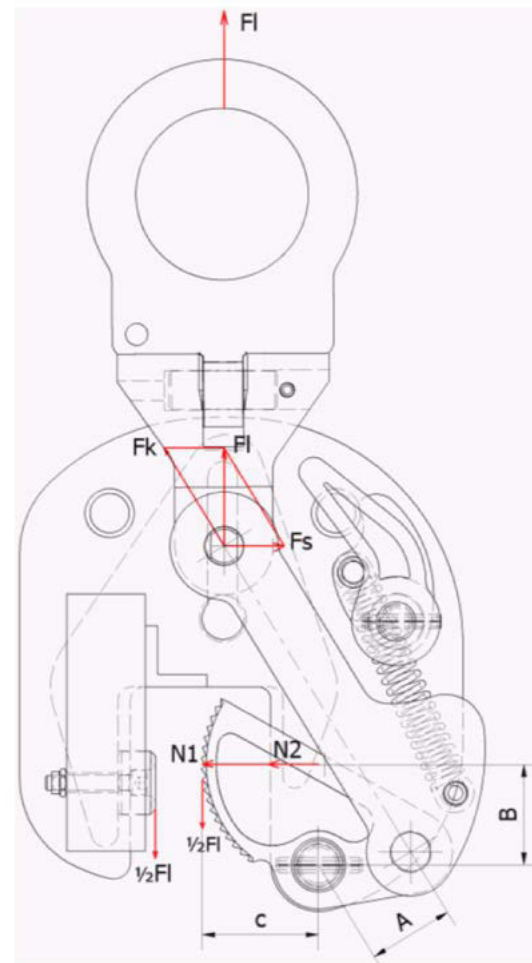

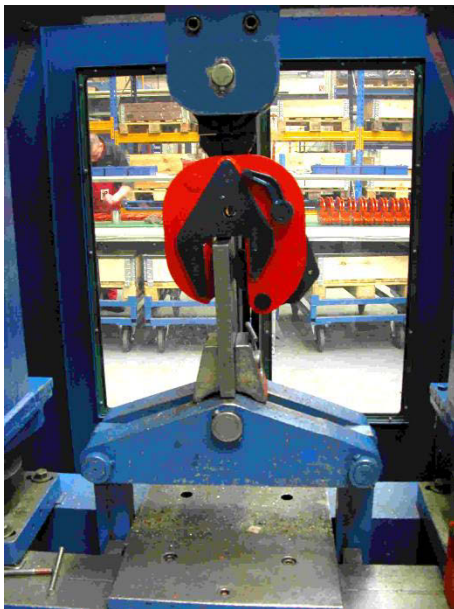

Strength lifting clamp; Minimal demands

2x the working load limit (WLL); no deformation

3x the working load limit (WLL); may have deformation but the load must be held

The design criteria of the clamp is based on EN13155 and ASME B30.20

All CrosbyIP clamps (up to 22,5t) are load tested with certification up to 200% of WLL

Markings CrosbyIP clamp:

1. Manufacturer
2. Minimum & maximum WLL
3. Type
4. CE marking
5. Serial number
6. Jaw opening (mm & inch)
7. Year of production
8. RFID equipped



All data are permanently stamped on body.

Delivered with clamp:

1. Terms and conditions of warranty - Maintenance log
2. User instructions
3. Proof Load Test Certificate
4. Warranty certificate

All in various languages.

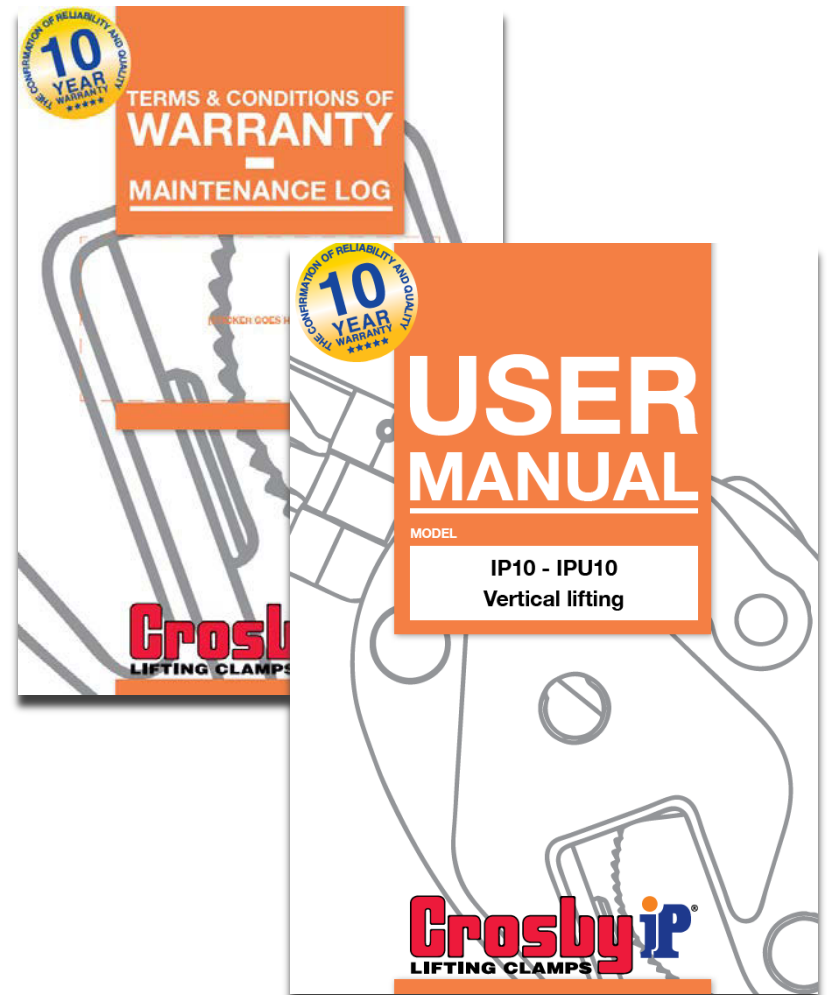

Easy to obtain spare parts

- Maintenance kits up to 9t for vertical clamps
- Repair kits up to 6t for vertical clamps
- Single spare parts for each clamp



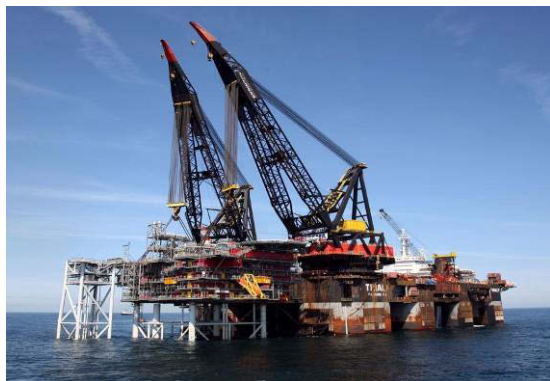

Offshore



Ship & yacht construction



Tank & vessel construction

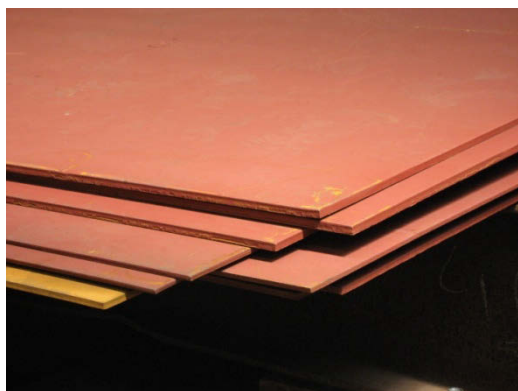

Steel constructions



Windpower energy



Aircraft industry

IP(U)10



HRC < 37

IP(U)10S(tainless steel)



HRC < 37

IP(U)10H(hard)

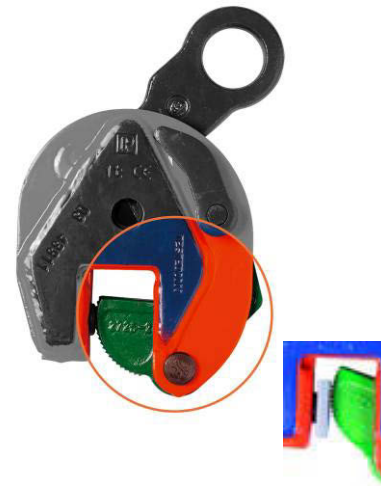

HRC < 47

IPNM10: Non Marring



HRC > 47

Minimal working load:

5% of stated WLL up to 27 HRC
10% of stated WLL up to 37 HRC

Minimal working load:

5% of stated WLL up to 27 HRC
10% of stated WLL up to 37 HRC

Minimal working load:

10% of stated WLL up to 47 HRC

Minimal working load:

No minimum WLL at any hardness

VERTICAL TRANSPORT

- IPU10 – IP10
- IPU10S – IP10S
- IPU10H – IP10H
- IPU10A – IP10A
- IPTPU - IPTPUX
- IPV(U)(N)Z
- IPNM10 – IPNM10J – IPNM10P



UNIVERSAL – FOR LIFTING IN ANY DIRECTION

IP10 & IPU10

WLL: 0,5 – 30 t IP(U)10

WLL: 6 – 30 t IP(U)10J
(larger jaw opening)

The IP(U)10 vertical lifting clamps are used for the lifting, turning, moving or vertical transfer of steel plates and constructions from horizontal to vertical and down to horizontal (180°).

The IPU10 has a hinged lifting eye that allows for the clamp to place and lift the load from any direction.

IP10



IPU10



IP10

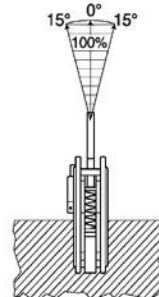
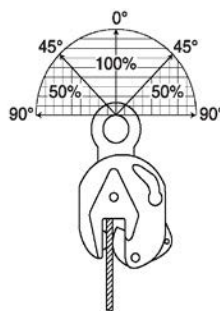

IPU10

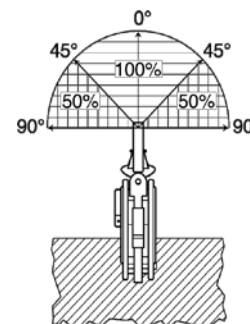
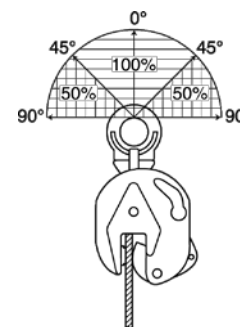



Vertical transport of various plates



IPU10



IP10

IP10 & IPU10

To be used with a single or multiple slings.

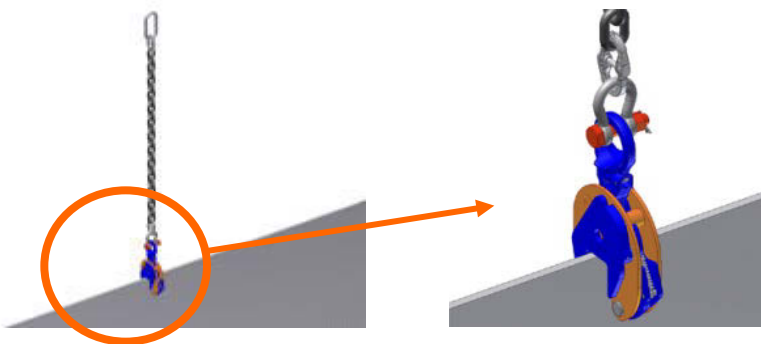

Use only IPU10 clamps in multiple leg sling applications.

WLL 12t

Clamps 12t WLL and up are fitted with special hook-up facilities to enable easy placement of the clamp in horizontal position.

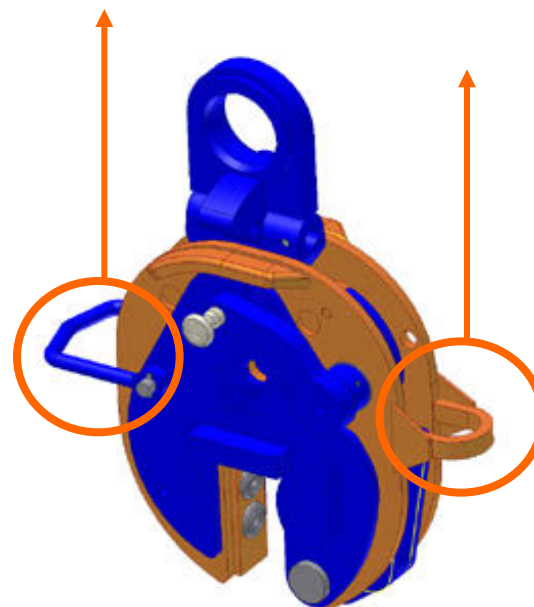



Welding strip

After the 2 smaller parts are welded together the partial ship deck is turned around by using an equalizing beam.

Then the other side is welded and transported to the almost finished ship deck.

IPU10



Vertical transportation of round fabrications or pipes

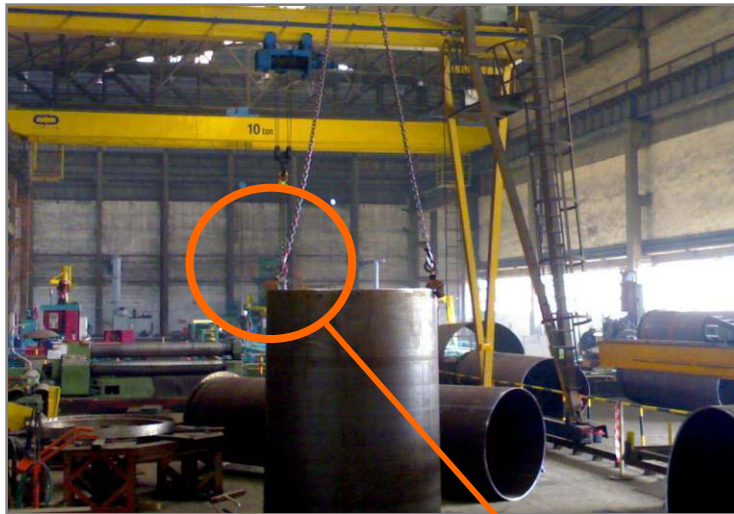

IP10S & IPU10S

WLL: 0,5 – 12 t IP(U)10S

FOR STAINLESS STEEL MATERIAL

Vertical lifting clamps are suitable for the lifting, turning (180°) and vertical transfer of stainless steel materials.

For use on materials with a surface hardness up to 37HRC. Fitted with a pivot and camsegment made of stainless steel to avoid contact corrosion.

IP(U)10S



IP10S

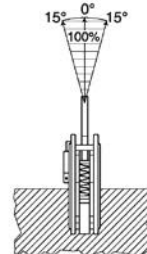
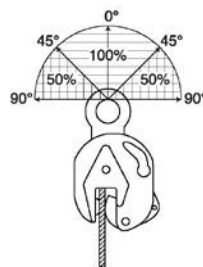

IPU10S

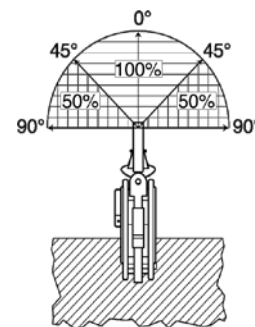
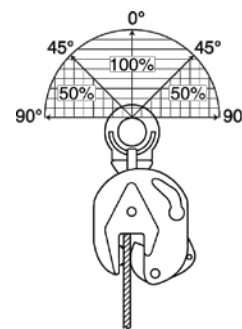

IP10H & IPU10H

WLL: 0,5 – 6 t IP(U)10H

HARD SURFACE MATERIAL

Vertical lifting clamps are suitable for the lifting, turning (180°) and vertical transfer of steel plates and sections with extra hard surface hardness.

For use on materials with a surface hardness up to 47HRC (450 HB). Fitted with a pivot and camsegment made of extra hard wear-resistant material.

IP(U)10H

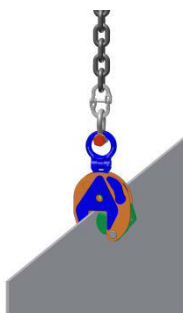

IP10H

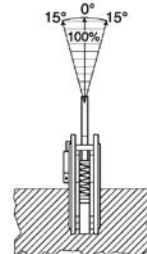
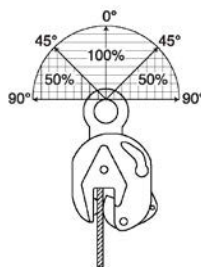

IPU10H

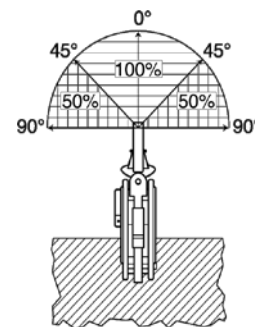
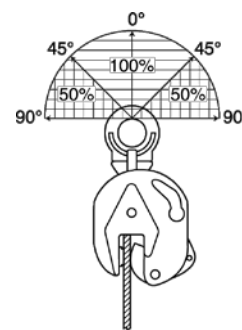

IP10A & IPU10A

WLL: 1 – 2 - 9 t IP(U)10A

AUTOMATICALLY LOCKING

The IP10A - IPU10A clamps automatically applies pre-tension on the material as soon as the clamp is placed on the plate, and stays in the locked position.

Applications for this clamp include placement on loads that are difficult to reach.

IP(U)10A



IP10A

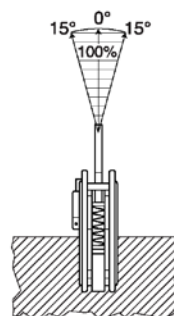
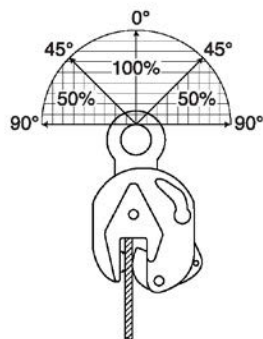

IPU10A

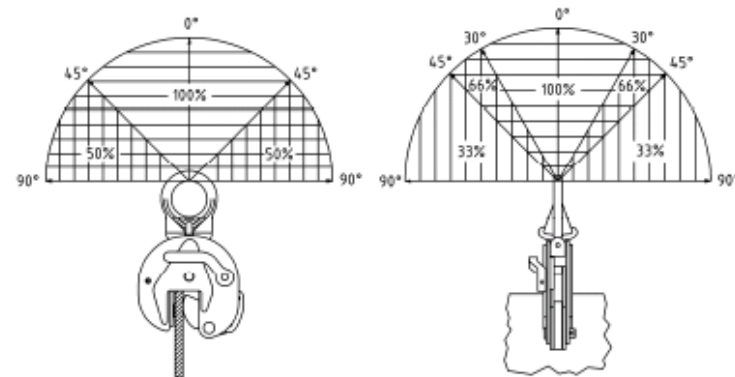



Determine Center of Gravity, and ensure the load is proportionally divided over the clamps.

IP(U)10A



IPTPU & IPTPUX

WLL: 1,5 – 3 t IPTPU

WLL: 1,5 – 3 t IPTPUX
(with supporting profiles)

FOR VERY THIN, LARGE PLATES

Used for lifting very thin, large plates from horizontal to vertical position and to turn them. The specific design of this model prevents the plates from 'buckling' while being lifted.

IPTPUX is equipped with lateral supporting profiles.

IPTPU



IPTPUX

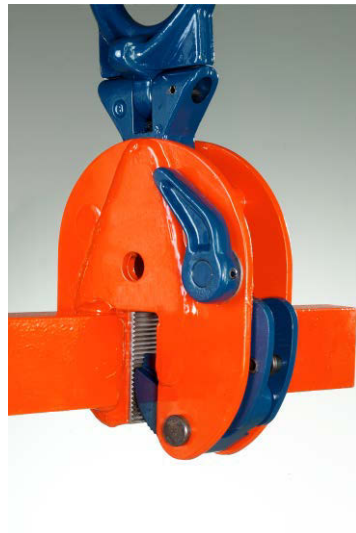

IPTPU

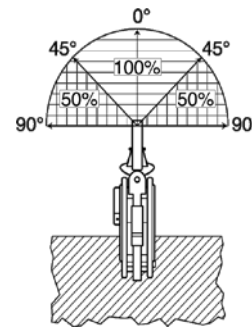

IPTPUX

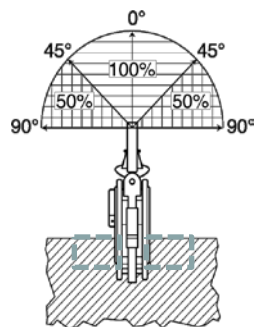
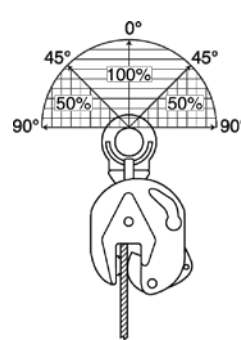

FOR SMALL PROFILES

IPV(U)(N)Z

WLL: 0,75 – 1,5 t IPV(U)(N)Z

The IPV(U)(N)Z is specially designed for the transfer of small profiles.

IPVZ; with fixed lifting eye

IPVUZ; with hinged lifting eye

IPV(U)NZ; for even smaller profiles

IPV(U)(N)Z



IPV(N)Z

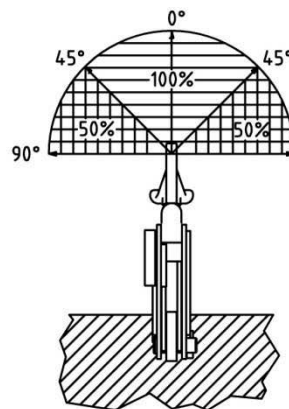
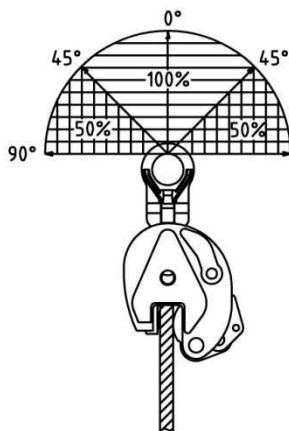

IPVU(N)Z

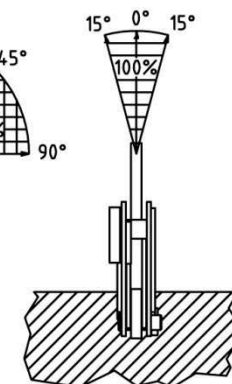
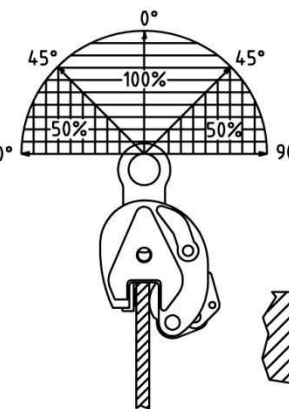

IPNM10 & IPNM10(J)(P)

WLL: 0,5 – 2 t IPNM10

WLL: 0,5 – 1 t IPNM10J
(larger jaw opening)

NON MARRING

The IPNM10 clamp is used for the lifting, turning, moving or vertical transfer of sheet, steel plates or fabrications from horizontal to vertical and down to horizontal (180°) as needed without marring the surface of the material.

Also available with protective cap (IPNM10P) to reduce risk of damage to surrounding plates. Also available the special IPNM10JC, with curved jaws.

IPNM10



IPNM10P



IPNM10(J)(P)

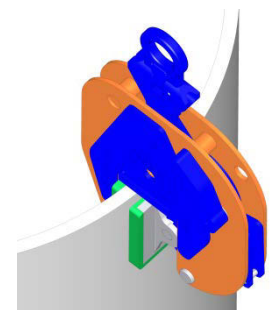
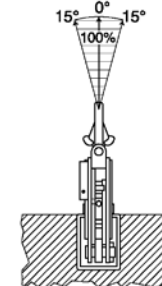
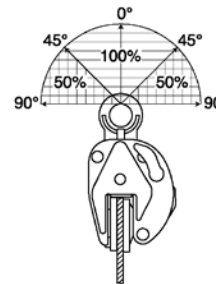

IPNM10JC

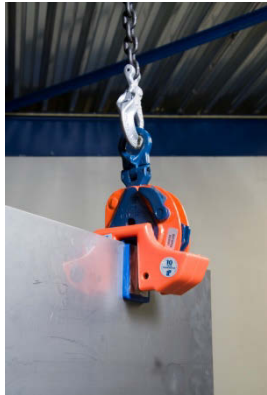

Refinishing of the material surface not needed with IPNM10 series.

To be used with;

**Aluminum, stainless steel,
painted materials, aircraft skins,
composite materials & plastics.**



HORIZONTAL TRANSPORT

- IPH10 - IPH10J - IPH10E
- IPHOZ
- IPHNM10
- IPBC
- IPHGZ - IPHGUZ
- IPPE



FOR HORIZONTAL LIFTING AND TRANSFER

IPH10(J)(E)

WLL per pair: 0,5 – 12 t IPH10

WLL per pair: 3 – 12 t IPH10J(E)
(larger jaw opening)

The IPH10 is suitable for lifting and transfer in horizontal position of non-sagging steel plates. The use of magnets ensures the clamps to remain in the proper position on the plate. Also equipped with a handle and torsion spring that combines to make the placing of the clamp onto the plate quick and easy.

These clamps must be used in pairs or more.

IPH10 0,5t - 1t : with spring

IPH10 2t - 12t : with torsion spring, magnets & handle

IPH10E 2t - 12t : with handle

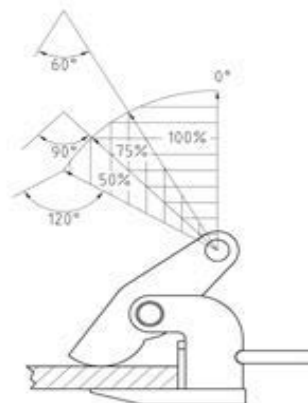

IPH10(J)(E)

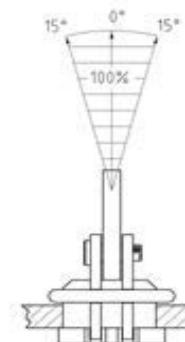



IPH10

Always be sure to use the right tools for the right application to ensure maximum reliability!

These clamps must be used in pairs or more.

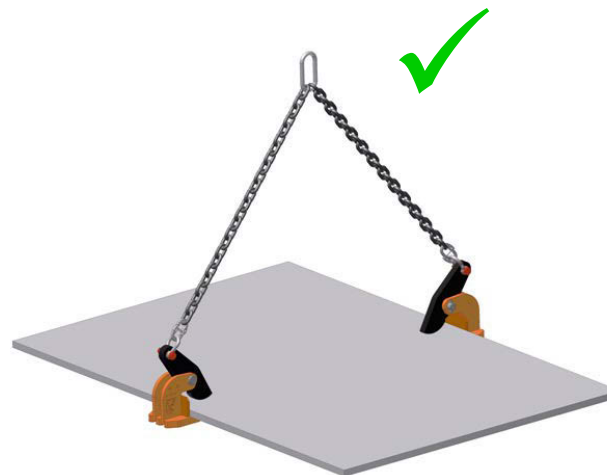

Lifting with 2 (or more) persons is **time consuming** and **expensive!**

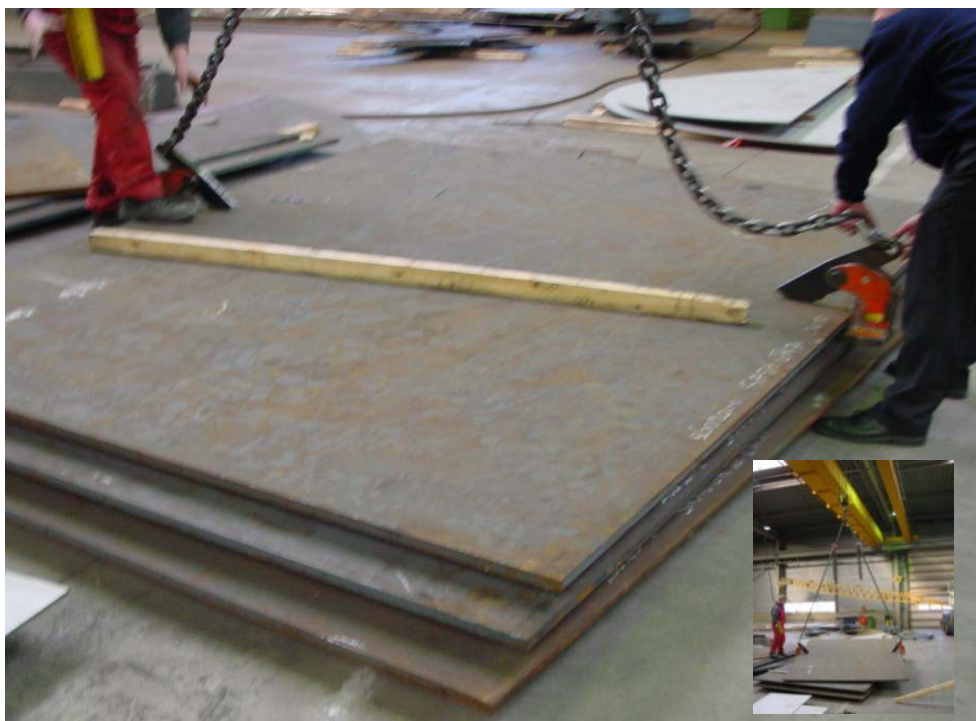

I PHOZ

WLL per pair : 0,75 – 15 t I PHOZ

FOR HORIZONTAL LIFTING OF SAGGING MATERIAL

The I PHOZ horizontal lifting clamp is to be used for lifting and transferring, in horizontal position, of thin sheet and other materials that will sag or bend when lifted.

Can also be applied in combination with long chains or two leg slings.

These clamps must be used in pairs or more.

I PHOZ

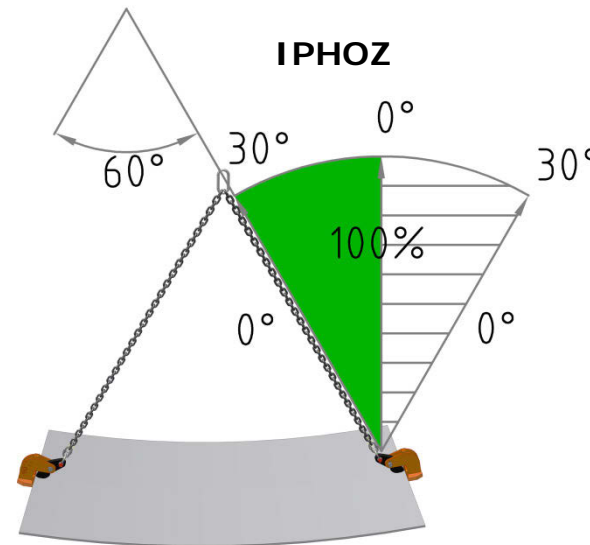

IPHNM10

WLL per pair : 0,5 - 2 t IPHNM10

WLL per pair : 2 t IPHNM10J
(larger jaw opening)

NON MARRING

The IPHNM10 horizontal lifting clamps have a pretension feature that allows the user to attach the clamps to the material for horizontal lifting and transfer of non-sagging material. To be used where material surface must not be damaged. Also applies for materials with a very smooth surface, composites and coated plates or plates with a very hard surface.

These clamps must be used in pairs or more.

IPHNM10

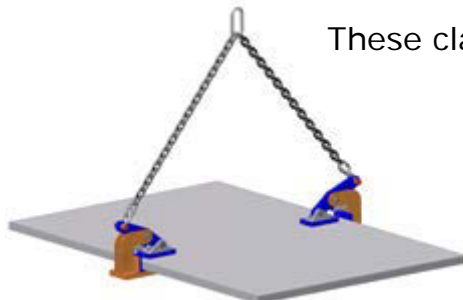

IPHNM10

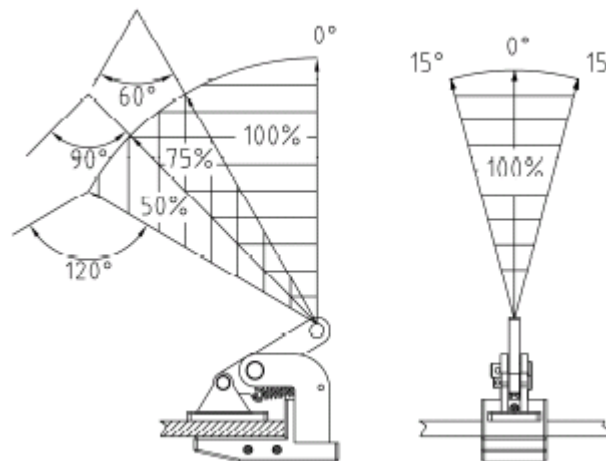

IPBC

WLL: 1 - 3 t IPBC

FOR HORIZONTAL TRANSFER – WITH PRETENSION

The IPBC horizontal lifting clamps have a pretension feature that allows the user to attach the clamps to the material for horizontal lifting and transfer of sagging and non-sagging material. These clamps may also be used to handle material that will be used in shears, bending and rolling machines or other fabrication equipment. For horizontal plate lifting, must be used in pairs of more.

Also to be used for turning beams from “H” into the “I” position.

IPBC

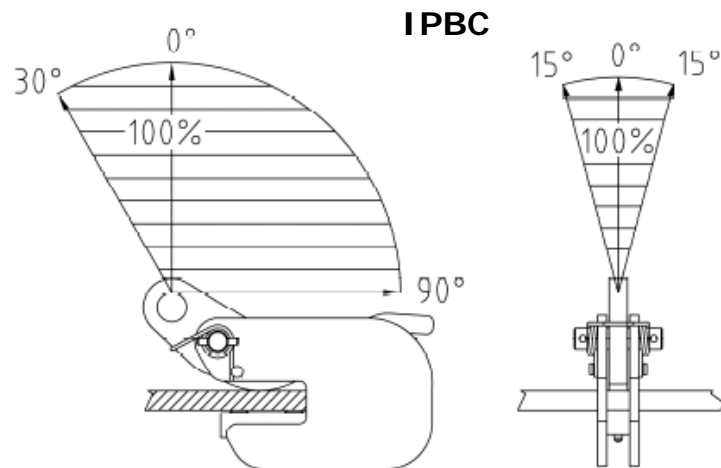
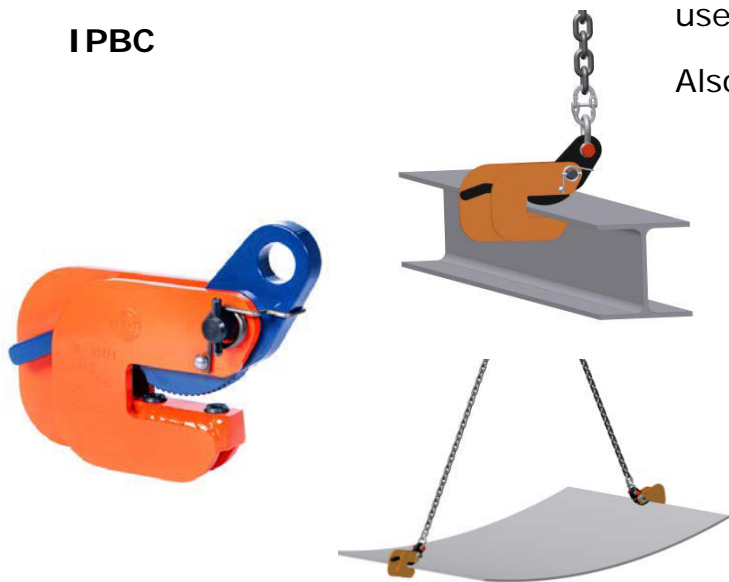

IPHGZ - IPHGUZ

WLL: 0,75 – 4,5 t IPHGZ

WLL: 1,5 – 4,5 t IPHGUZ

FOR HORIZONTAL TRANSFER – WITH LOCKING DEVICE

The IPHG(U)Z lifting clamps have a pretension locking feature that allows the user to attach the clamps to the material for horizontal lifting and transfer of sagging and non-sagging material. These clamps may also be used to handle material that will be used in shears, bending and rolling machines or other fabrication equipment. May also be used to move and lift structural shapes such as I-Beams, H-Beams etc.

IPHG(U)Z



IPHGZ

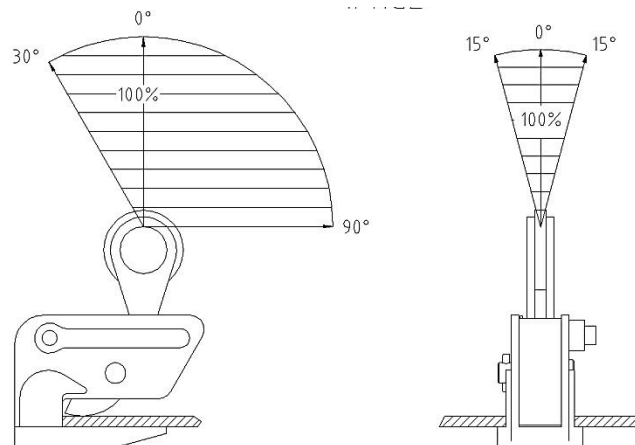



IPHGUZ Lifting angles!

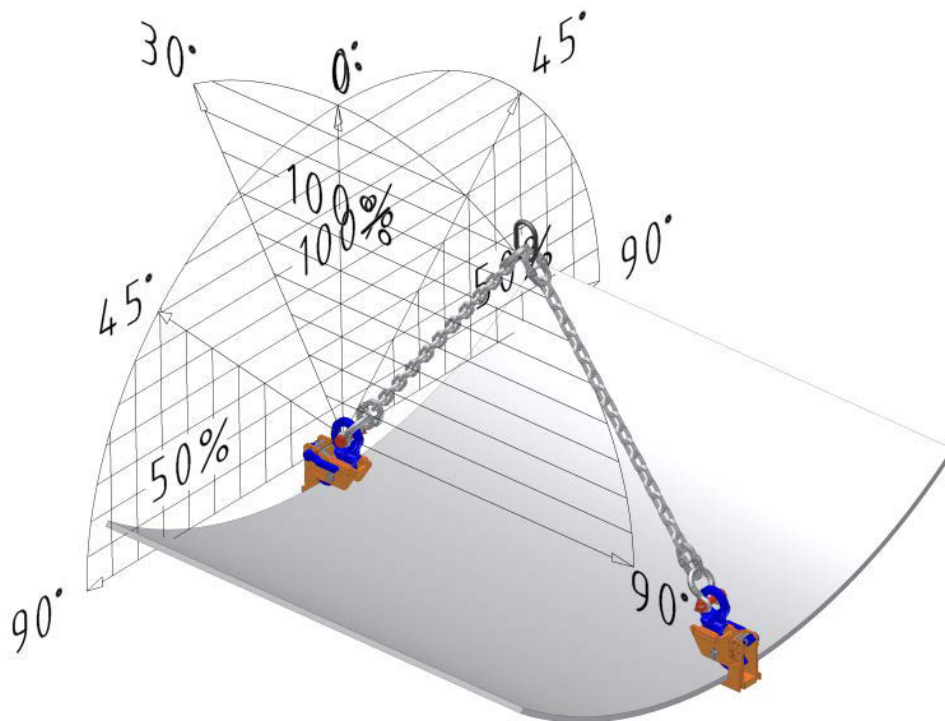

Controlled tilting by using correct lifting angles

IPHG(U)Z

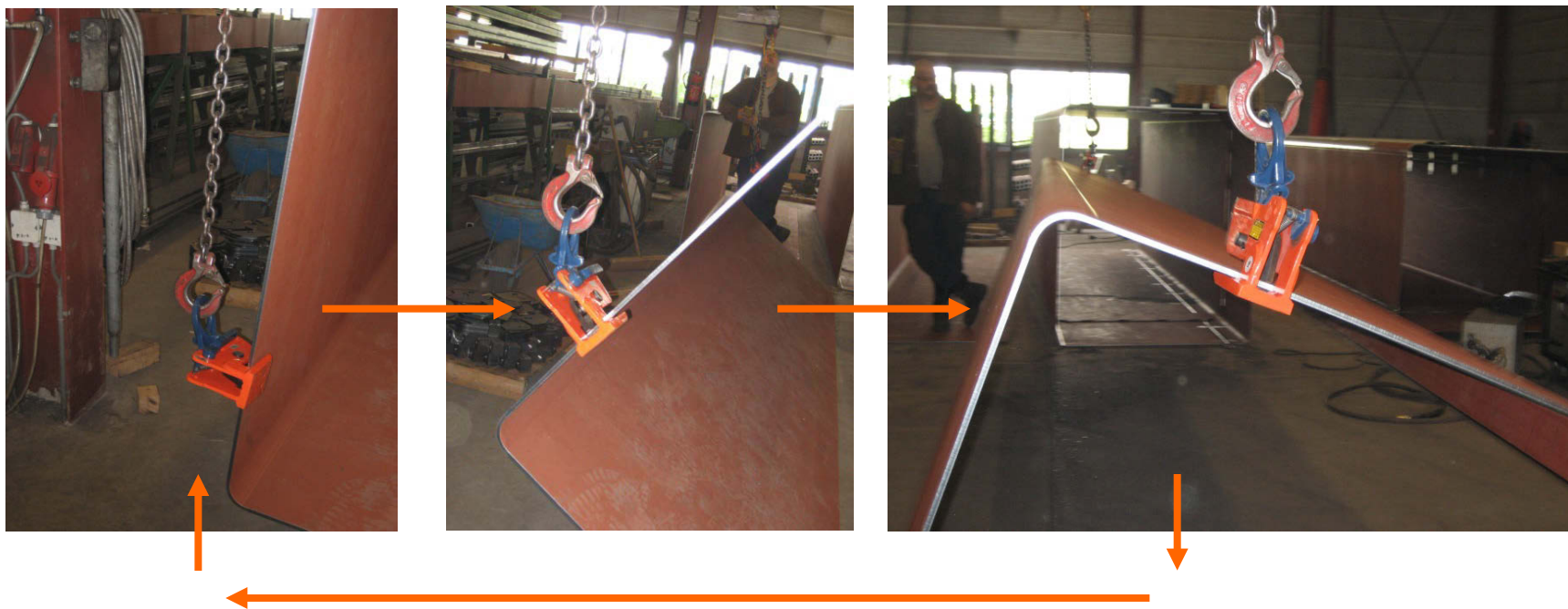

IPHG(U)Z

Spring assembly

Used to protect the crane and the lifting equipment from the great impact of the press.

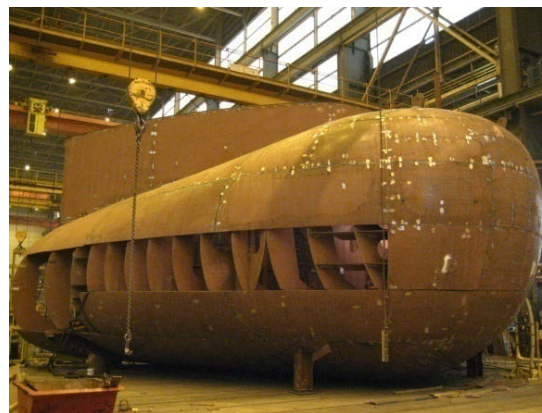

At shears and bending machines, with springs.

IPPE

WLL per pair: 3 - 12 t IPPEB (0-180 mm)

WLL per pair: 3 - 12 t IPPED (0-300 mm)

WLL per pair: 3 - 12 t IPPEH (0-420 mm)

IPPE

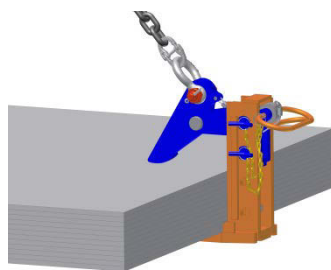

FOR LIFTING AND TRANSFER OF BUNDLES OF PLATES

The IPPE is suitable for the lifting and transfer of bundles of non-sagging steel plates in horizontal position.

The jaw opening can easily be adjusted. Raising the handle opens the clamps. This facilitates the easy and quick placing or removing of the clamps.

Must be used in pairs or more.

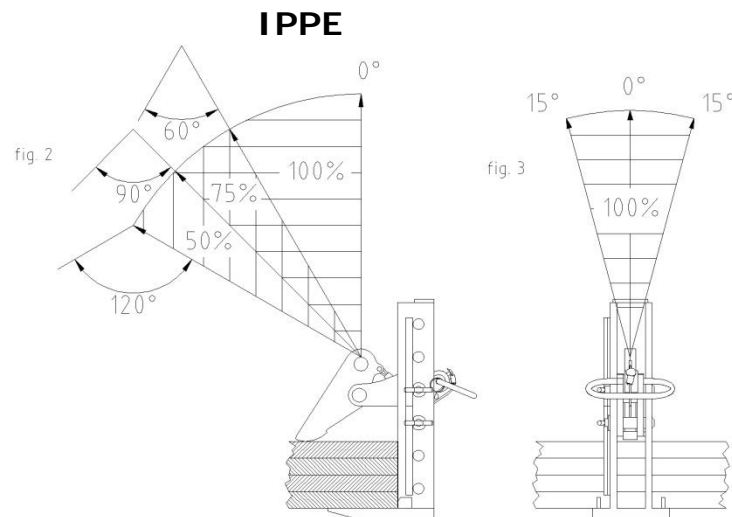

HORIZONTAL TRANSPORT OF BEAMS

- IPTKU - IPTKUD
- IPBKZ
- IPBHZ
- IPBSNZ
- IPSTARTEC11

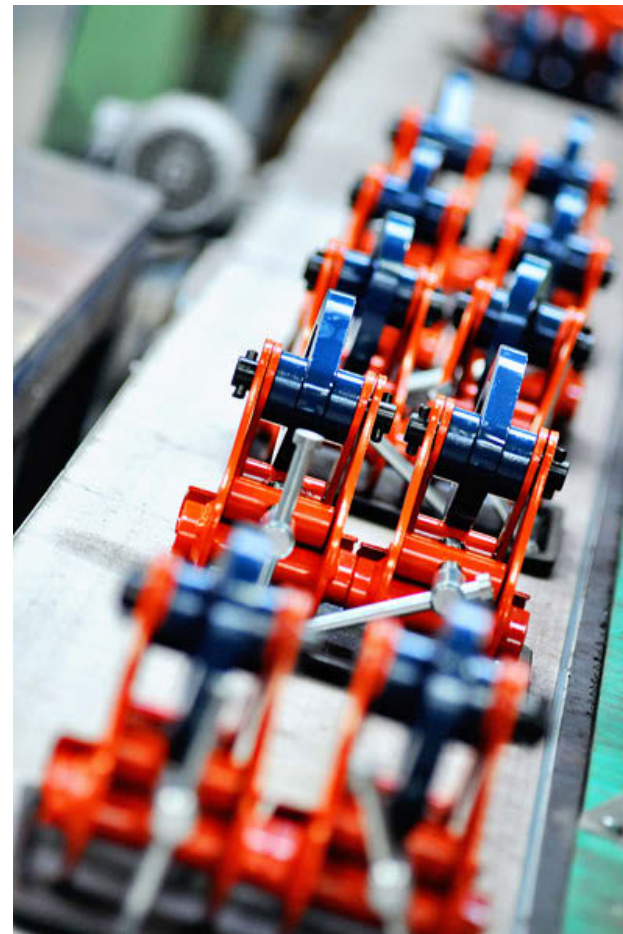

IPTKU - IPTKUD

WLL: 2 – 10 t IPTKU



IMPROVED UNIVERSAL BEAM CLAMP

Suitable as a temporary tackle eye for a beam, lifting clamp and as a lashing clamp. The hinged and enlarged lifting eye increases the loading angles.

The IPTKU clamp is designed with a hexagon-head handle that allows easy opening and closing with a wrench (pneumatic or electrical) and optional a second locking device (IPTKUD). Frame can be galvanized.

Also available: IPTKUM for personal fall arrest. Sheradised and with double locking

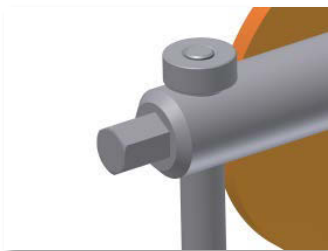

Hexagon-head handle

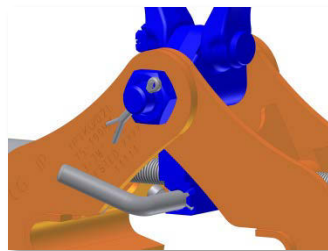

Double locking

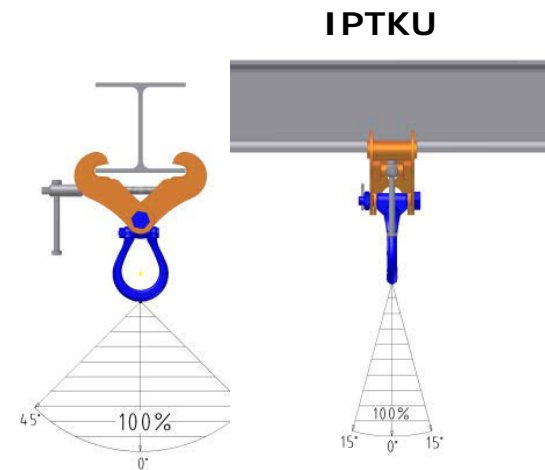

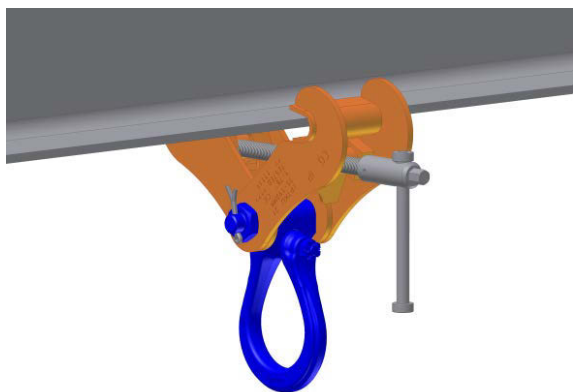

IPTKU tackle eye

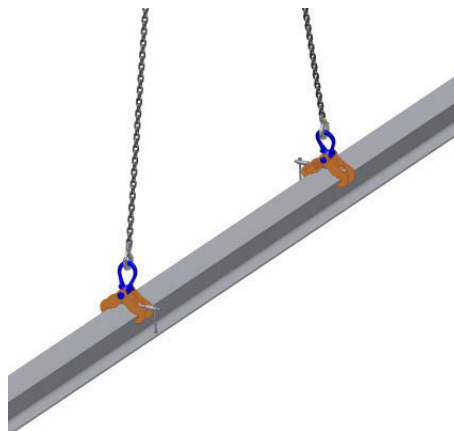

IPTKU lifting clamp

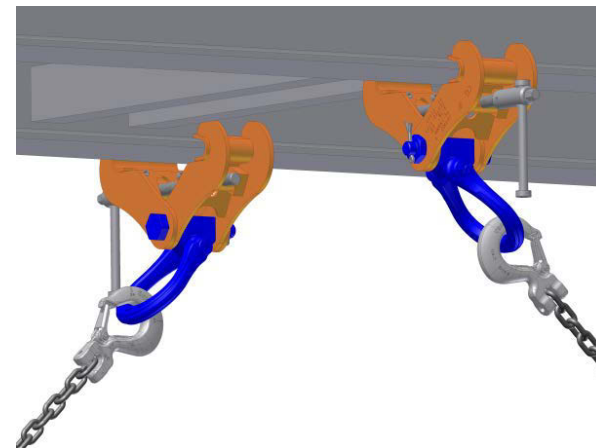

IPTKU lashing clamp

IPTKUM



PERSONAL FALL ARREST

The IPTKUM is suitable as an anchor device for 1 person, for the attachment of components forming part of a personal fall arrest protection system.

Galvanised (sheradised) frame and supplied with a double locking device.

Supplied with test certificate according to; EN 795:1996-07

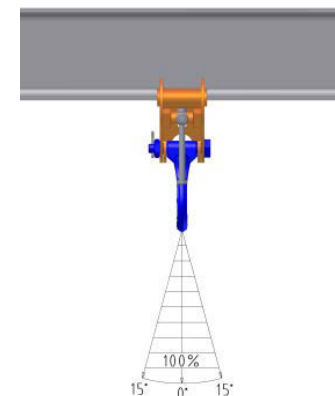
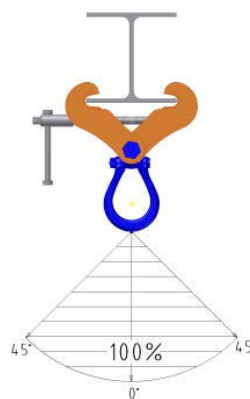

FOR THE TRANSFER AND STACKING OF STEEL BEAMS

IPBKZ

WLL: 0,75 – 3,75 t IPBKZ

The IPBKZ beam clamp is used for lifting, transfer and stacking of H & I-Beams with the flange to remain in vertical position. This is created through an over-center lifting eye. This series of clamps can be used for vertical lifting and horizontal moving of beams, angles, etc., with the flange in vertical position, depending on the application desired.

IPBKZ



IPBKZ

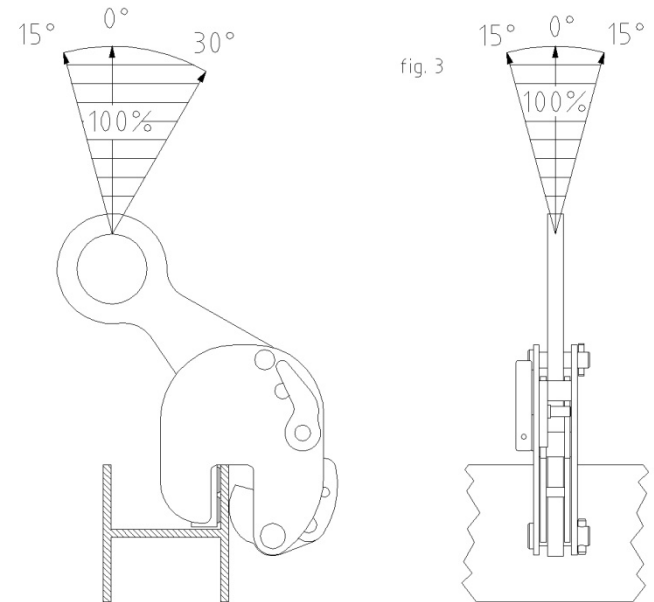

IPBHZ

WLL: 0,75 – 12 t IPBHZ

FOR THE LIFTING AND TRANSFER OF STEEL BEAMS

The IPBHZ beam clamp is used for horizontal lifting and transfer of steel beams. The base is slotted to allow the clamps to be used from end of beams as well as from the flange. This series of clamps can be used in the vertical and horizontal lifting, transfer and stacking of different types of structural designs, such as I-Beams, H-Beams, angles, etc., depending on the application desired. Also for handling large pipe sections.

IPBHZ

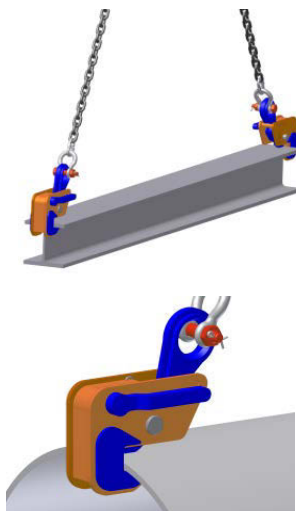

IPBHZ

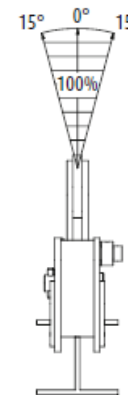
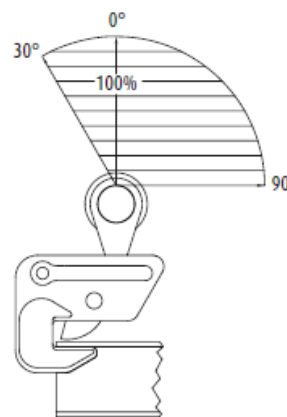

IPBHX special clamp

for lifting and transfer of
pipes and tubes

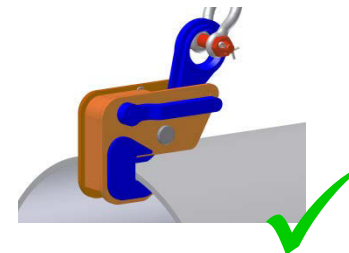

IPBSNZ

WLL: 1,5 – 4,5 t IPBSNZ

**FOR THE LIFTING, TRANSFER AND STACKING
OF STEEL BEAMS**

The IPBSNZ beam clamp is used for lifting, transfer and stacking (the hoisting eye allows for level lifts) of beams in the I-position. Also for lifting fabrications and ship sections. Can be used in the vertical lift and horizontal moving, transfer and stacking of different types of structural designs, such as I-Beams, depending on the application desired.

IPBSNZ

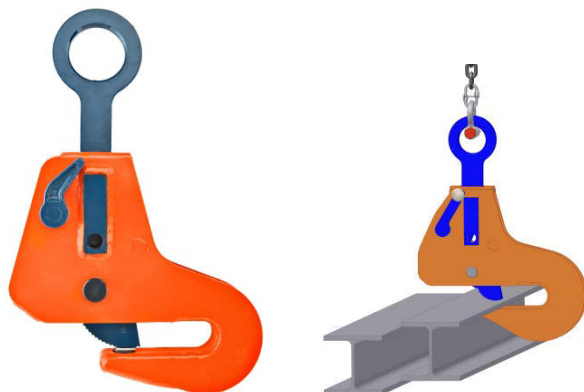

IPBSNZ

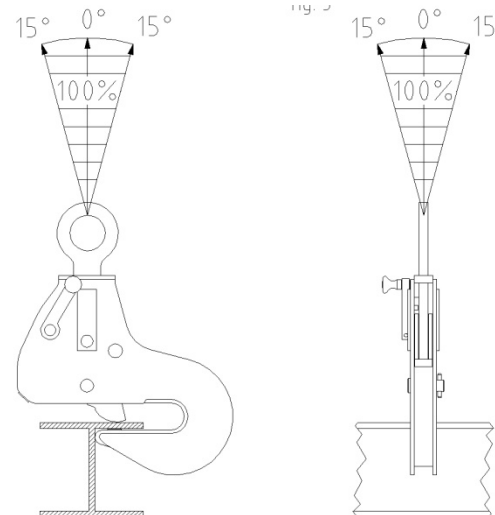

IPSTARTEC11

WLL: 1,5 – 2,5 t IPSTARTEC11

FOR CONTROLLED TILTING AND TRANSPORT

The IPSTARTEC11 beam clamp has been specially designed for lifting with the web in vertical position, controlled tilting, transportation and stacking of steel "H" and "I" profiles.

By placing the chain guide in the appropriate position, it is easy to switch from lifting to tilting and back again, which shifts the centre of gravity.

IPSTARTEC11



IPSTARTEC11

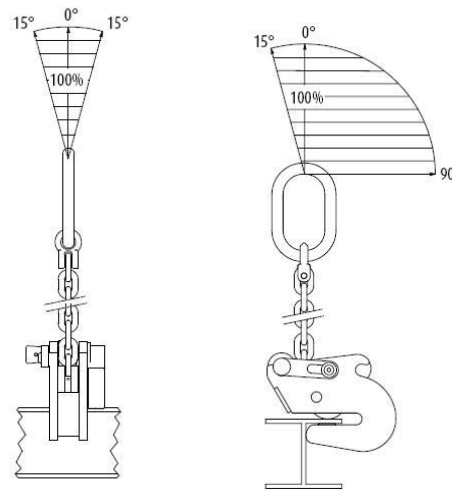

Controlled tilting



Transport IPSTARTEC11

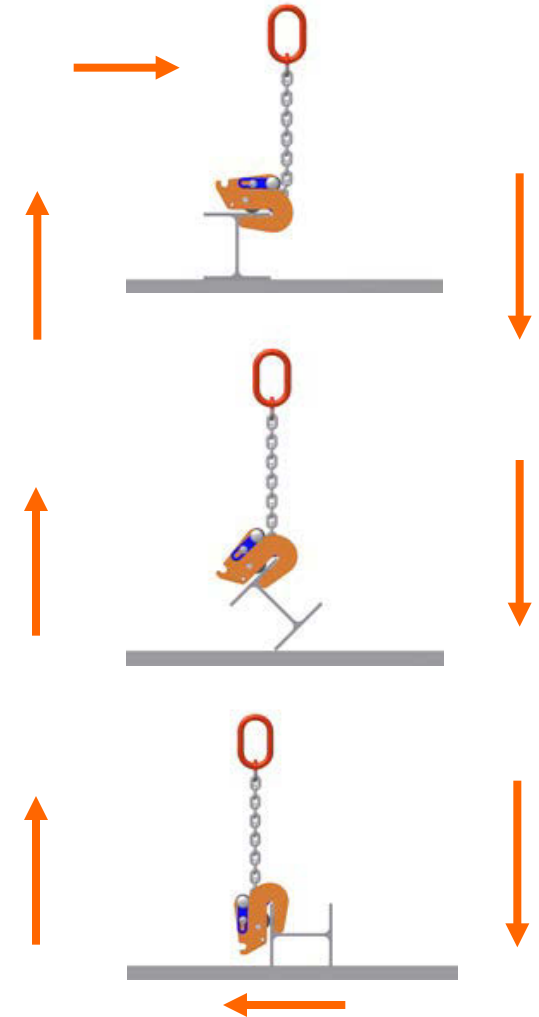

MISCELLANEOUS

- IPVK
- IPDV
- IPCC
- IPBUZ - IPBUUZ
- IPSBU(U)Z - IPSBUS(U)Z
- IPBTO10
- IPSE
- IPSC



IPVK

WLL: 0,5 t



The IPVK drum clamp is for vertical lift and transfer of 215 to 225 liter drums with steel tops (50-55 gallon). Automatically locks on drum. Can be used separately or in pairs.

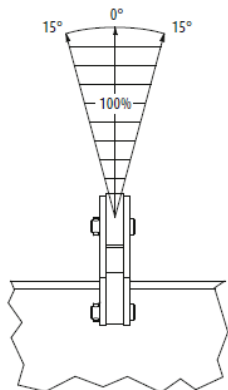

IPDV

WLL: 0,5 t



The IPDV drum clamp is for vertical lift and transfer of 215 to 225 liter drums with steel tops (50-55 gallon). Allows drum to remain in an upright position during lift.

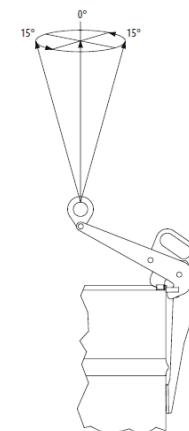

IPCC

WLL per pair: 1 t

IPCC



FOR PIPE SECTIONS

The IPCC is suitable for vertical lifting and transfer of concrete pipe sections and wells. Very easy application and removal of clamps thanks to the built-in carrying-grips.

These clamps must be used in pairs or more.

Normally used with 7 mm chain (not included).

IPCC

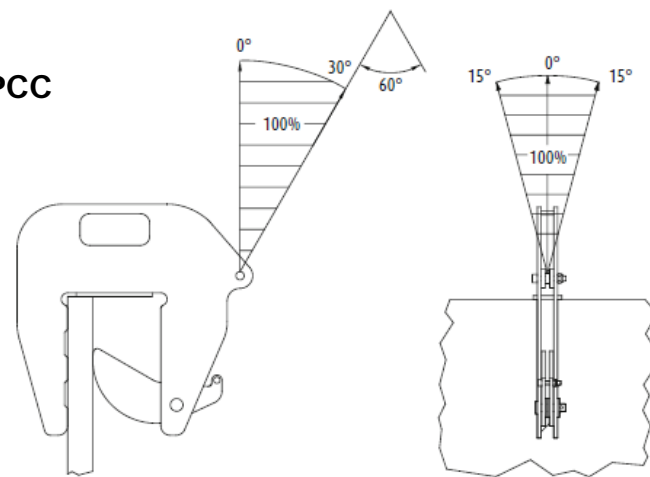

IPBUZ - IPBUUZ

WLL: 0,75 – 3,75 IPBU(U)Z

IPBU(U)Z

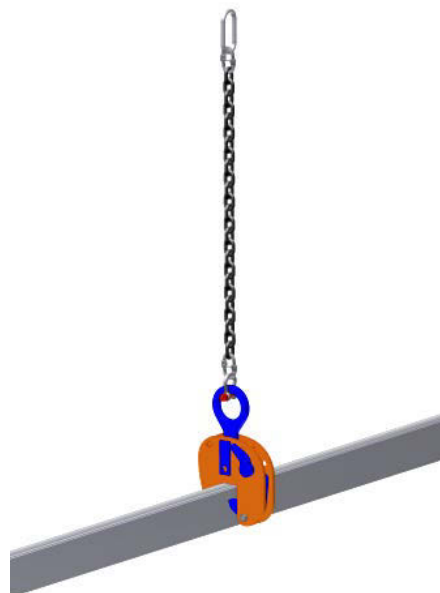

FOR BULB PROFILES

The IPBU(U)Z shipbuilding clamps are used for the lifting, transfer and placing of bulb profiles onto ship sections perpendicularly. These clamps are fitted with a locking device for both open and closed positions, which ensures complete reliability.

To be used exclusively for bulb profiles (not for plates).

IPBUZ

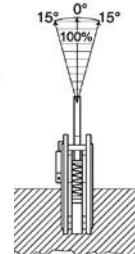
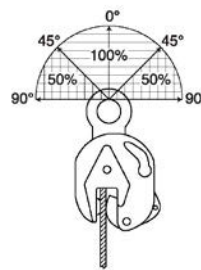

IPBUUZ

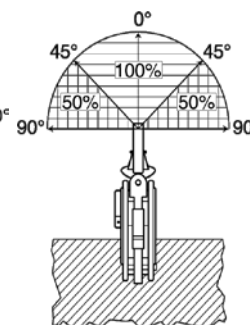
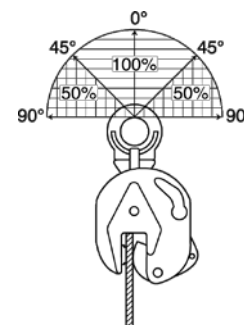

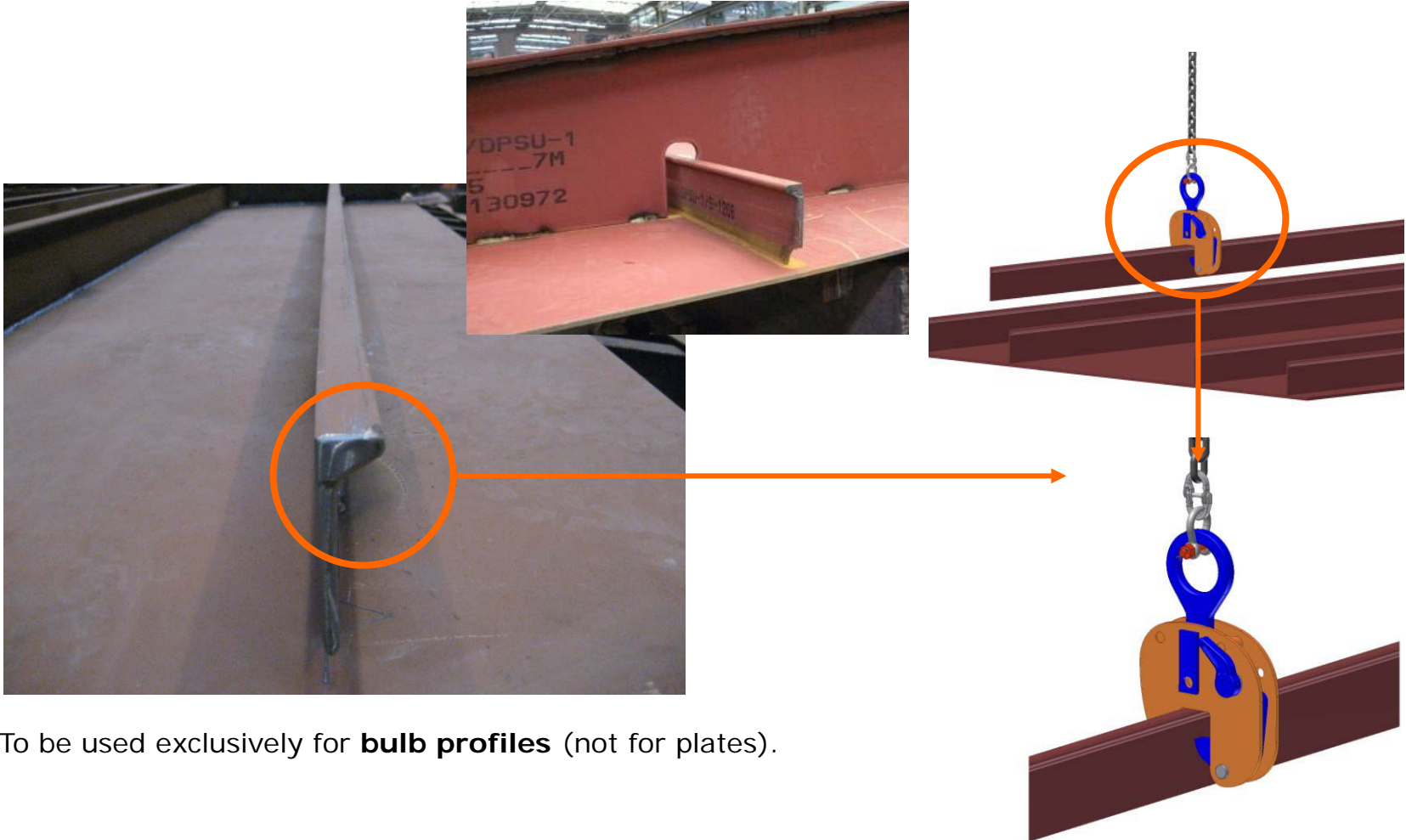

To be used exclusively for **bulb profiles** (not for plates).

IPSBUZ - IPSBUUZ

WLL: 4,5 – 9 t IPSBU(S)UZ

WLL: 4,5 – 22,5 t IPSBU(S)Z

FOR SHIP SECTIONS

The IPSBU(S)(U)Z shipbuilding clamps are used for the lifting, transfer and placing of bulb profiles onto ship sections perpendicularly. These clamps are fitted with a locking device for both open and closed positions, which ensures complete reliability.

To be used exclusively for bulb profiles (not for plates).

IPSBU(U)Z

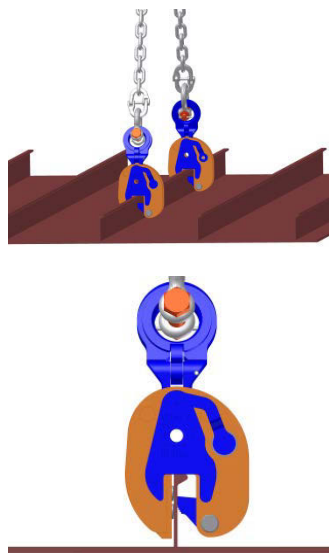

IPSBU(S)Z

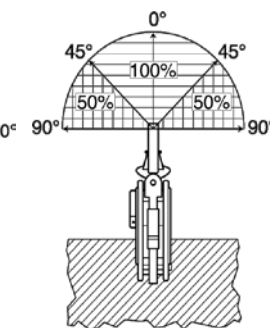
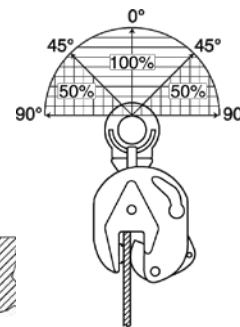
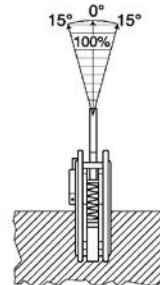
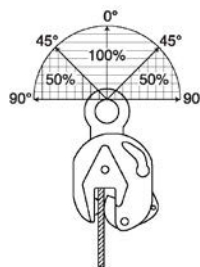

IPSBU(U)Z

WLL: 4,5 – 9 t IPSBU(S)UZ

WLL: 4,5 – 22,5 t IPSBU(S)Z

IPSBU(U)Z



Transport of ship section by using IPSBUSUZ lifting clamps.



Temporary lifting eyes are attached to the deck plates to enable transport. After transport the lifting eyes are removed again.

= Time consuming.

IPSBUUZ



IPBTO10

WLL: 1,5 – 6 t

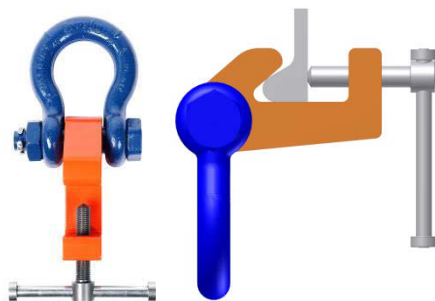

The IPBTO10 is used as a temporary tackle eye in spaces which have been reinforced with HP (bulb) profiles such as engine rooms and ship sections.

Fitted with screwed spindle for easy attachment of the clamp.

Clamp automatically fixes when load is applied.

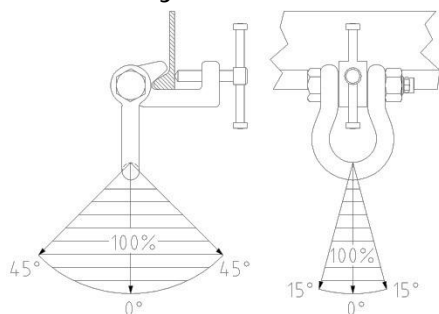

IPSC

WLL: 1,5 – 3 t

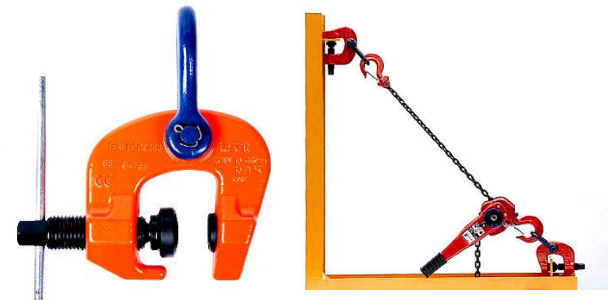

The IPSC screw style clamp is for positioning and pulling of plates or fabrications.

Not to be used as a lifting clamp!

For steel with a surface hardness up to 30 HRC.

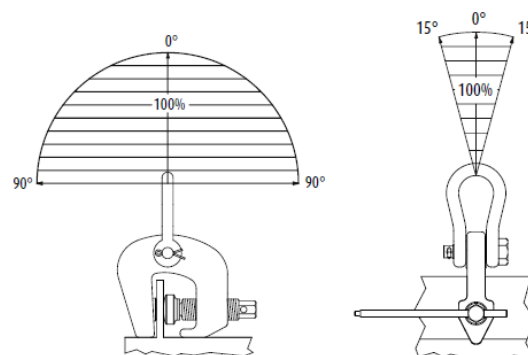

IPNM10JC (Jaw Curved)

Also available the special IPNM10JC, designed for lifting very hard surfaces.

The curved jaws makes it suitable for pipes and tubes, without marring the surface of the material.

Dimensions upon request.



REMOTE CONTROLLED CLAMP

The IP(U)10R is specially designed to be opened and closed from a distance with a rope, attached to the clamp.

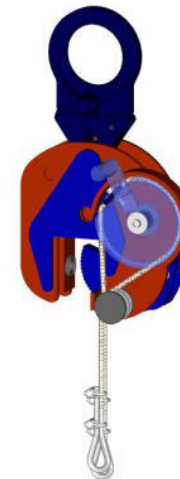

DEEP JAW opening

The IP(U)10J2 is designed to grab over a beveled edge to ensure maximum grab and reliability.



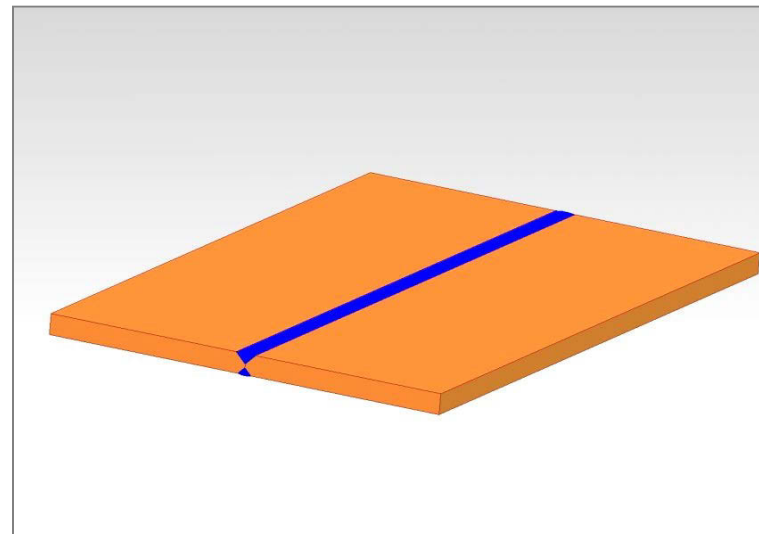

IP(U)10J2

Clamp specially designed to transport very thick plates with a large beveled edge.

Clamp has an extra deep jaw because of the large beveled edge. The deep jaw is designed to prevent the plate from moving within the jaw.



ALUMINUM BILLET CLAMPS

The IPSNX clamp is manufactured for lifting aluminum billets out of the pit and turn the billet into a horizontal position.

Not to be used to pick up the billet in the horizontal position.

BILLETS

The 5 IPNX has specially been developed for lifting round billets.

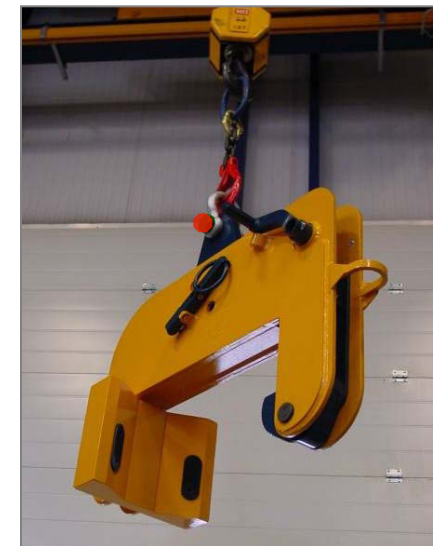

MINIMAL MARRING

The IPGNS is a minimal marring clamp for WLL up to 6t, with either steel or stainless steel clamping plates which allows the clamp to be used in wet circumstances.



SHIP SECTIONS

For lifting big ship sections by gripping on the web of the beam (instead of the flange).

The IPSE is able to lift up to WLL 50 t.



IPGNS





- Top quality
 - Durable
 - 100% proof tested at 2x WLL
 - Welded body
 - Fewer parts
 - 10 years warranty (Not in USA)
- Body and main parts are traceable (serial number)
- Marking with minimum and maximum WLL, CE, jaw opening, serial number
- User friendly
 - Compact and ergonomic
 - Lighter weight
- Easy repair
 - Fewer parts
 - Easy to disassemble/reassemble
 - Availability of parts and kits
 - Tolerance lists available for repair (through factory trained repair personnel)
- RFID equipped
- Broad product line
- Development of specials on request
- Product innovations





Reinforced welded body:

Because of a welded frame the clamp is more robust and lighter weight thru the use of alloy steel plate.

Besides it is easy to disassemble/reassemble.

All vertical lifting clamps are equipped with “Lock Open/Lock Closed” feature that allows pretension before lifting.

Pretension:

All vertical clamps have pretension.

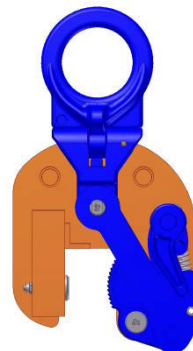

Latch:

The design of the latch shows when the clamp is in the “Lock Open” or “Lock Closed” position. When the latch is in the closed position, it is in-line with the frame, avoiding interference with the load.

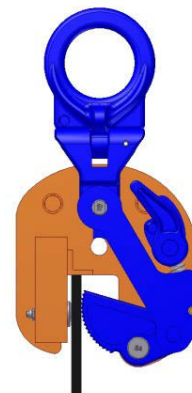

“Machined Flats” on lifting eye shaft

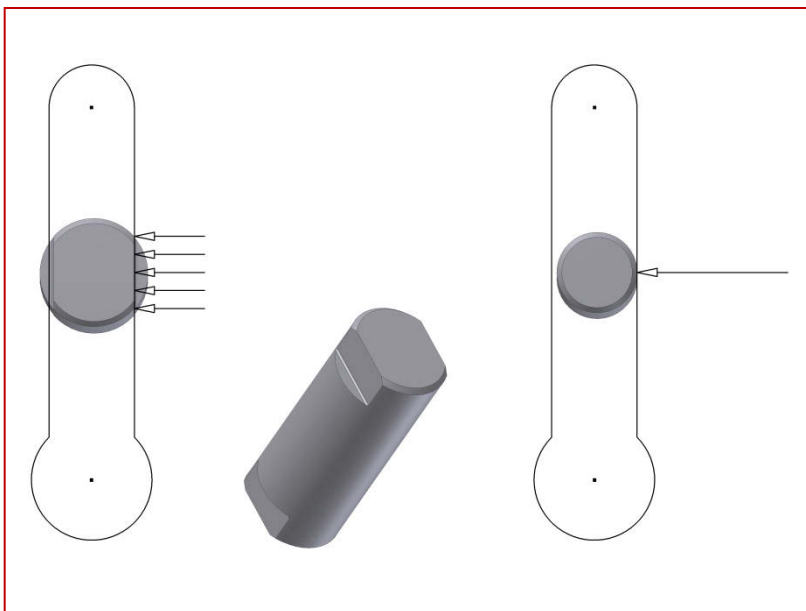

CrosbyIP

Others



Safety first! / La sécurité avant tout!

General / Généralités

- Hook WLL = 2T / Avoir de l'écart WLL = 2T
- Minimum steel = 2T / Avoir l'acier à 2T
- Extra hard steel > 2T = 4T / Avoir de l'acier durifié au moins 2T WLL et 4T WLL
- No Sharpen / Ne ruser

- Minimum load is 10% of clamp's rated W.L.L.
- Charge minimale autorisée: 10% de la C.M.U. nominale de la pièce

Round surfaces / Surfaces rondes

W.L.L. (C.M.U.)	Clamp Size	Min. material thickness	Min. material diameter
2	IP310	round 40 mm	30 mm
1	IP310	round 60 mm	40 mm
45	IP310	round 80 mm	40 mm
1	IP310	round 80 mm	30 mm

Vertical and horizontal lifting / Levage vertical et horizontal

- Determine Center of Gravity, and ensure the load is proportionally divided over the clamps
- Après avoir déterminé le centre de gravité, vérifier que la charge est également répartie entre les pinces.

Copyright Crosby Europe n.v. November 2008

02490000 PAVLINEK P1000

Vertical transport / Levage vertical

- Never exceed the W.L.L.
- Ne jamais dépasser la C.M.U.
- Never lift more than 1 plate at a time
- Une seule plaque par levage
- Lifting angle larger than 45° = lower W.L.L. by 50%
- Angle de levage supérieur à 45° = C.M.U. à réduire de 50%
- Never use a crane hook too large and/or too heavy for the lifting eye
- Crochet de grue trop grand et/ou trop lourd pour l'œil de levage
- Never pull plates from under a pile
- Ne jamais essayer de retirer des plaques de la base d'une pile

Horizontal transport / Levage horizontal

- Never use a vertical clamp for horizontal lifting
- Ne jamais utiliser une pince de levage vertical pour un levage horizontal
- Never exceed lifting angles
- Ne jamais dépasser les angles de levage
- Lifting angle larger than 45° = lower W.L.L. by 50%
- Angle de levage supérieur à 45° = C.M.U. à réduire de 50%

Maintenance / Maintenance

- Ambient temperature and/or temperature of load material
- Température ambiante et/ou matériau
- Keep gripping surface and load surface clean
- Nettoyer les surfaces de préhension de la pièce et le matériau

WARNING:

Read, understand and follow the instructions and the product information in applicable operator's manual before using clamps. Only trained and competent personnel should install, operate, inspect and repair this equipment. Only use genuine Crosby IP replacement parts.
Lire, comprendre et suivre les instructions d'utilisation du produit figurant dans le manuel d'utilisation avant de faire usage de la pince. Seules les personnes compétentes devraient pouvoir mettre en place, utiliser, contrôler et réparer cet équipement. N'utiliser que les pièces de rechange IP d'origine.

General



Steel

HRC < 37



Stainless steel

HRC < 37



Extra hard steel

HRC < 47



Non Marring

HRC > 47



Minimum working load:

5% of stated WLL up to 27 HRC

10% of stated WLL up to 37 HRC

10% of stated WLL up to 47 HRC



Round surfaces

WLL (t)	Clamp	Min. inside diameter	Max. wall thickness
0,5	IP(U)10	Round 160 mm	16 mm
1	IP(U)10	Round 160 mm	20 mm
2	IP(U)10	Round 400 mm	30 mm
3	IP(U)10	Round 600 mm	40 mm
4,5	IP(U)10	Round 600 mm	40 mm
6	IP(U)10	Round 600 mm	50 mm

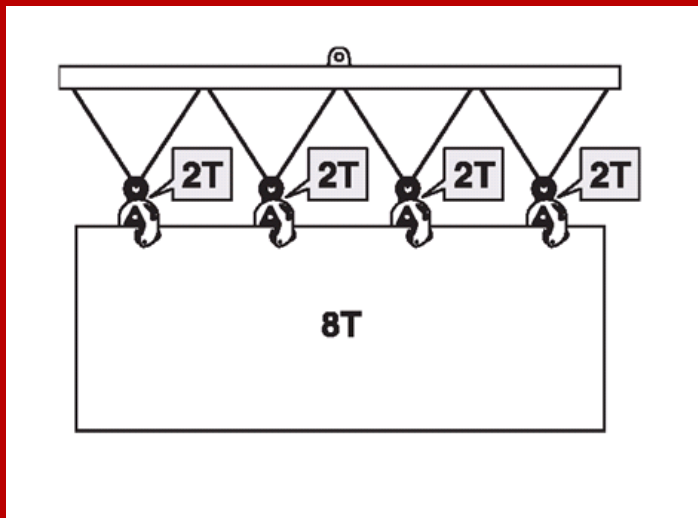

Use of multiple clamps

Determine Center of Gravity and ensure the load is proportionally divided over all clamps

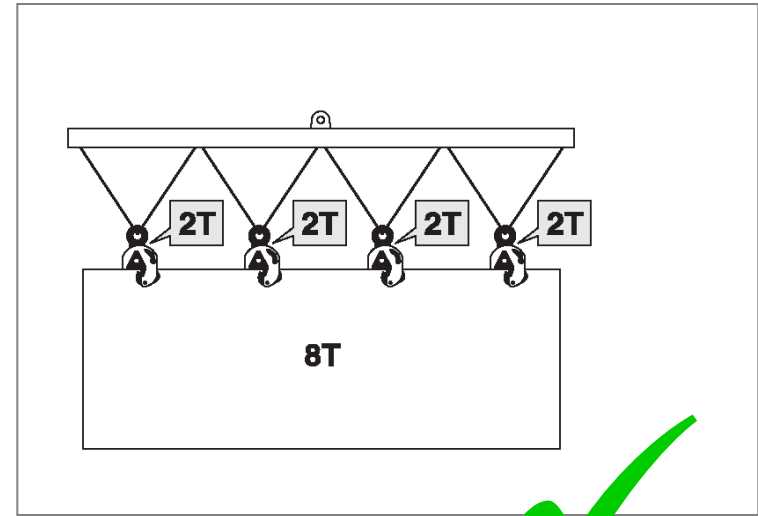

Use an equalizing beam to ensure an equal share of load to all clamps.

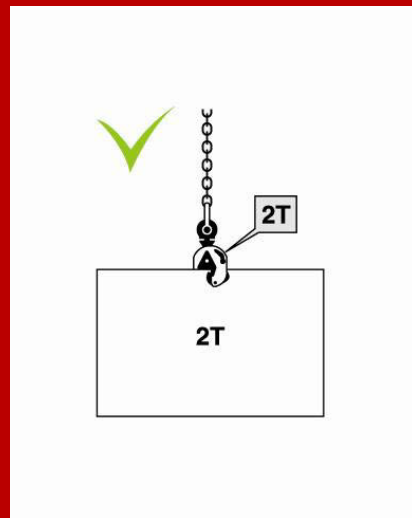
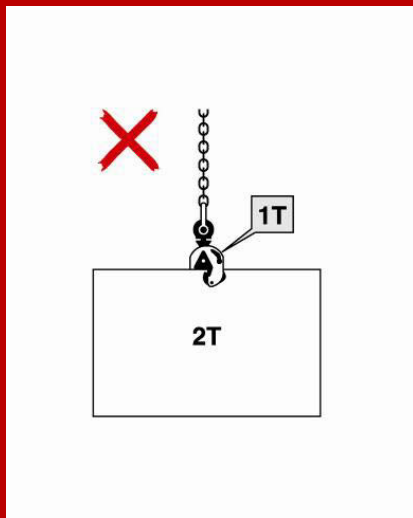

Vertical transport

Never exceed the WLL

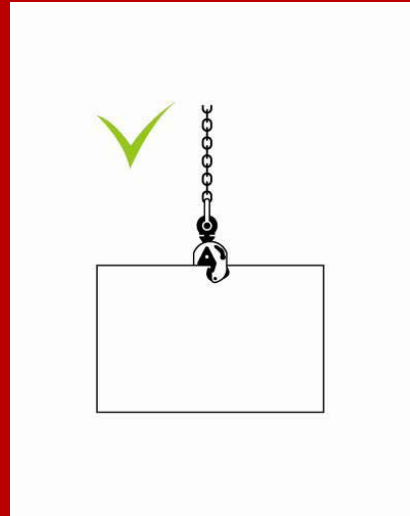
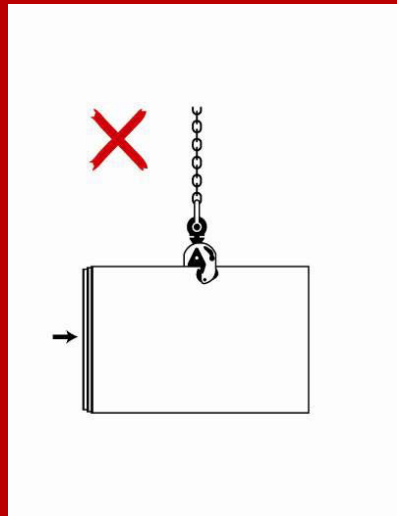

Vertical transport

Never lift more than 1
plate at a time

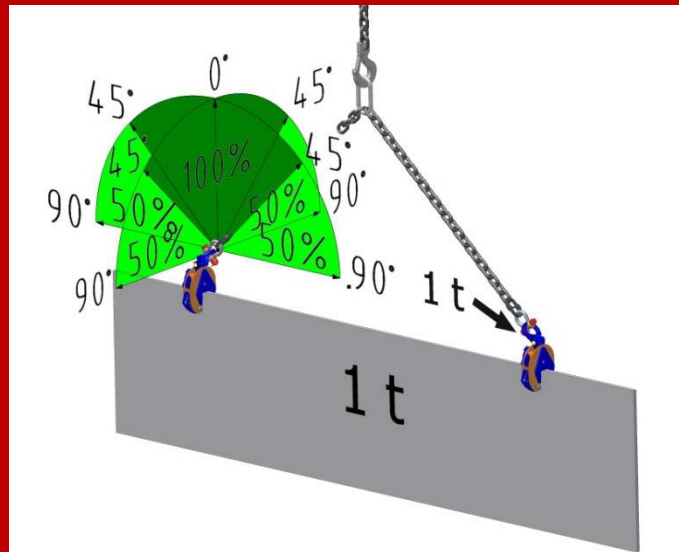

IPU10 Vertical transport

Lifting angle larger than 45° ?

= lower WLL by 50%

Do not overload by exceeding lifting angles !

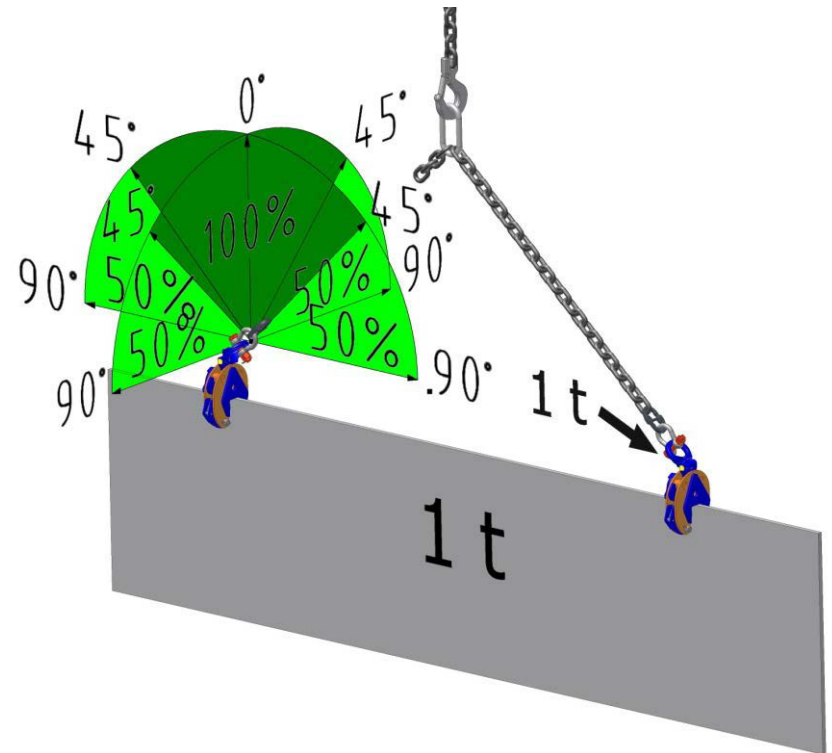
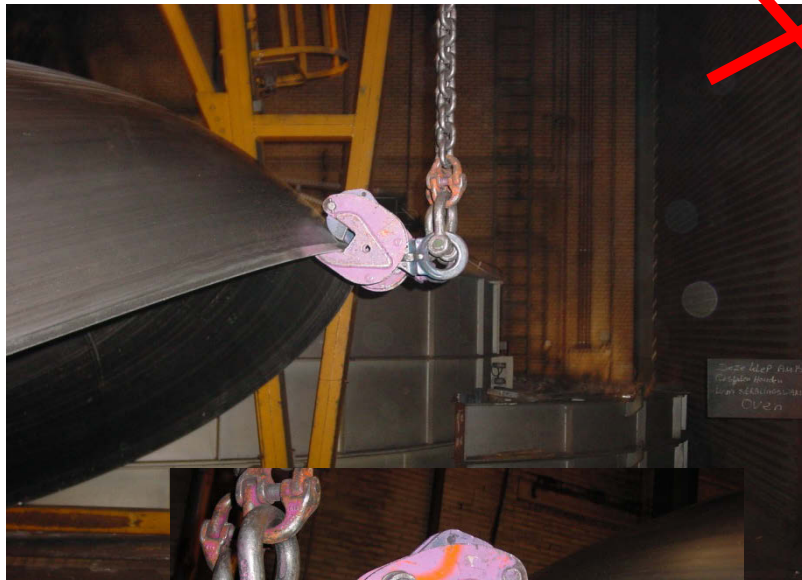

IPU10

Lifting angles

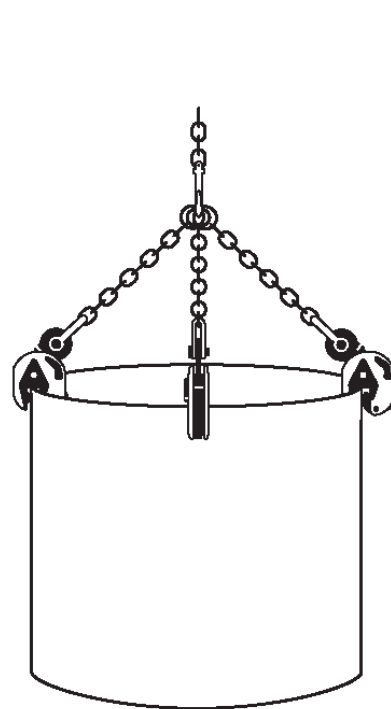
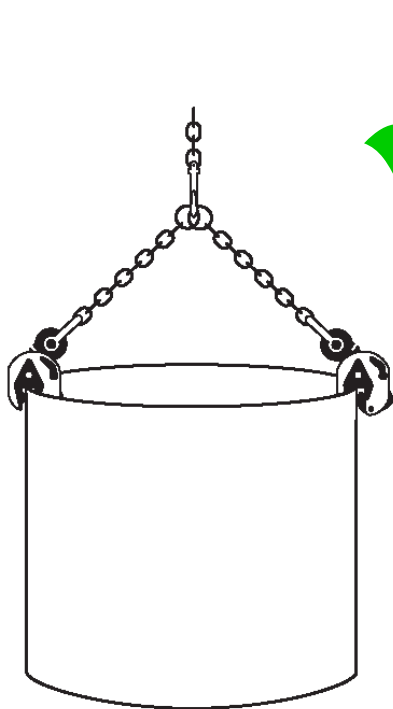

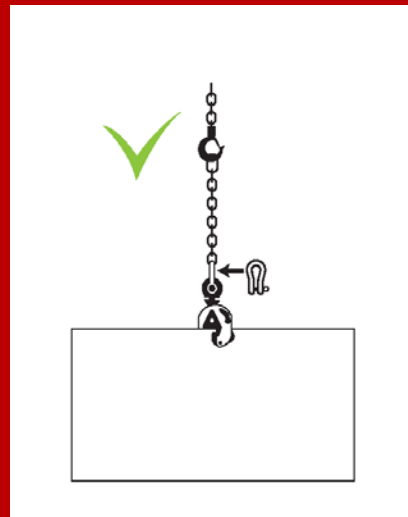
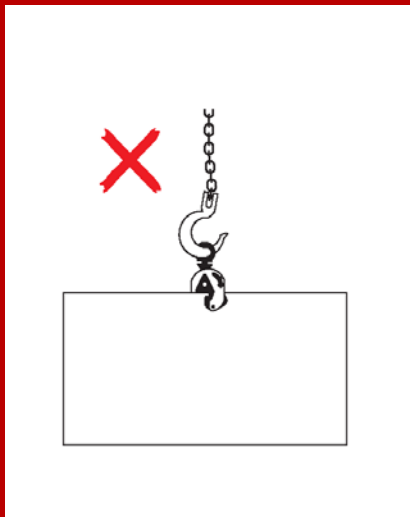

Vertical transport

Never use a crane hook which is;

- too large and/or
- too heavy for the lifting eye

The weight could open the clamp.

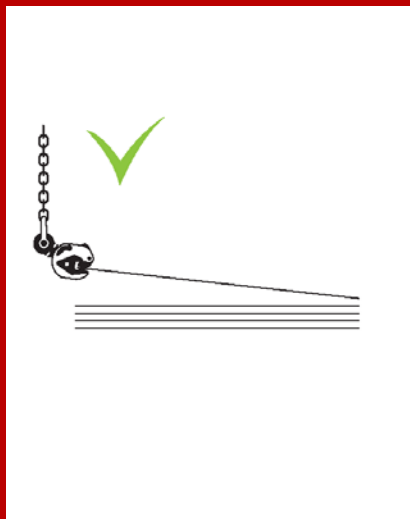
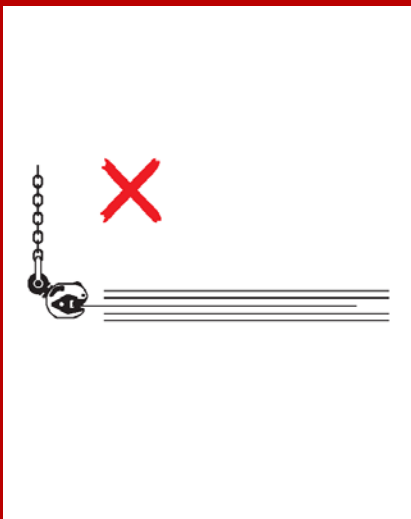

Vertical transport

Never pull plates from
under a pile

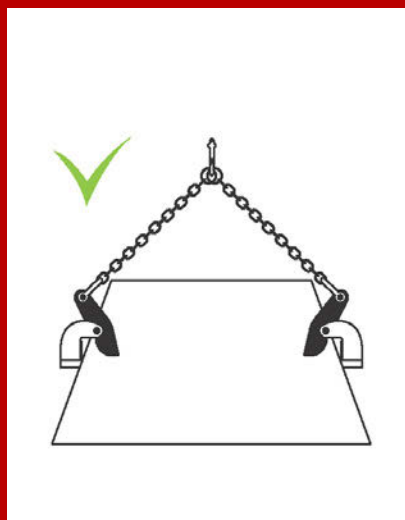
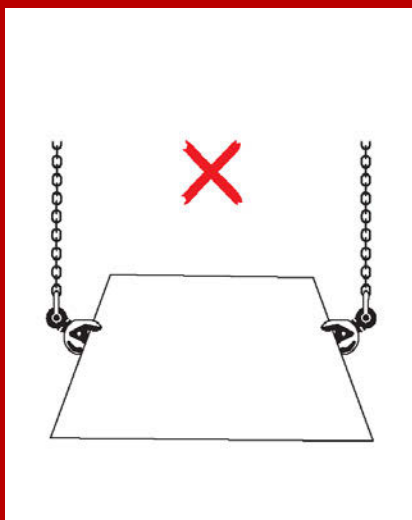

Horizontal transport

Never use a vertical clamp for horizontal lifting

Never use a **vertical clamp** for **horizontal lifting** !



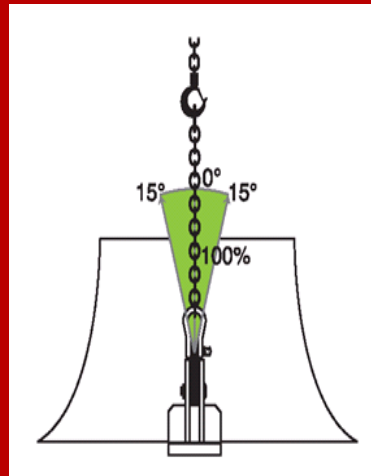
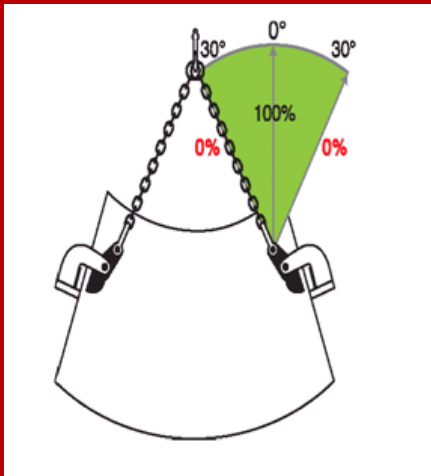

Horizontal transport Sagging Plates

Never exceed lifting
angles

IPHOZ

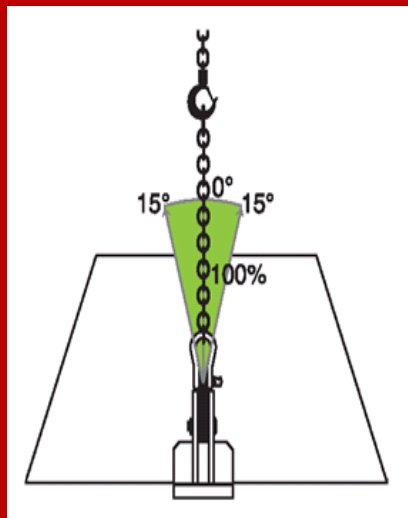
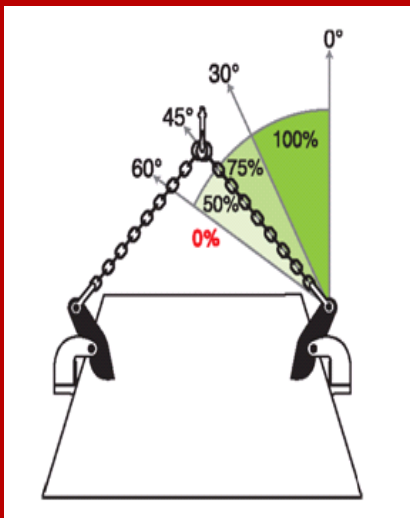

Horizontal transport
Non sagging Plates

Lifting angle larger than 45° = lower WLL by 50%

IPH10 Series

Maintenance



- 40° C (-40° F)



+ 100° C (212° F)

Ambient temperature
and/or temperature
of load material

Maintenance

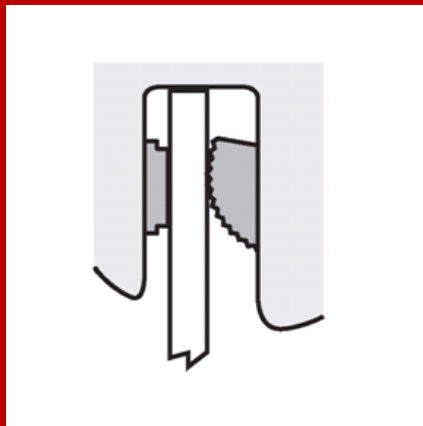
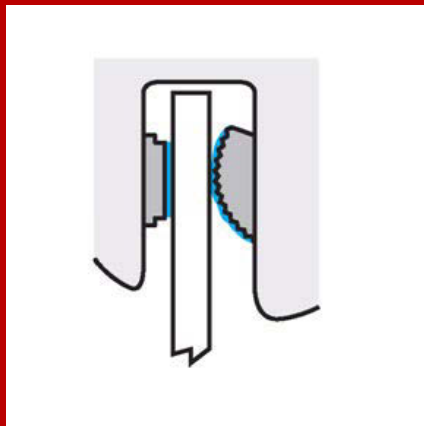

Keep gripping
surface and load
surface clean

Read, understand and follow the **instructions** and the **product information** in applicable user manual before using the clamps (per EN13155 and ASME B30.20).

Only **trained** and **competent personnel** should install, operate, inspect and repair this equipment.

Only use **genuine** CrosbyIP replacement **parts**.



Be sure to work with a real CrosbyIP clamp!

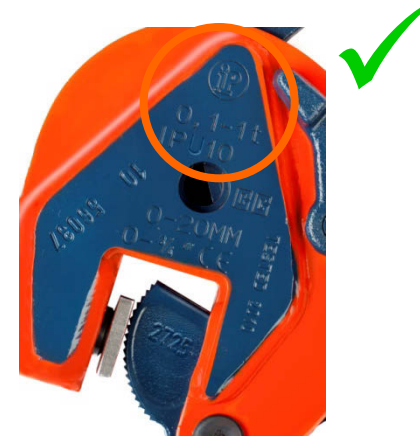
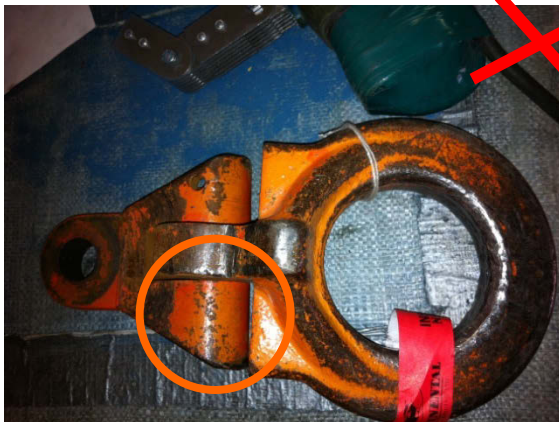

Always use the right clamp for the right application!

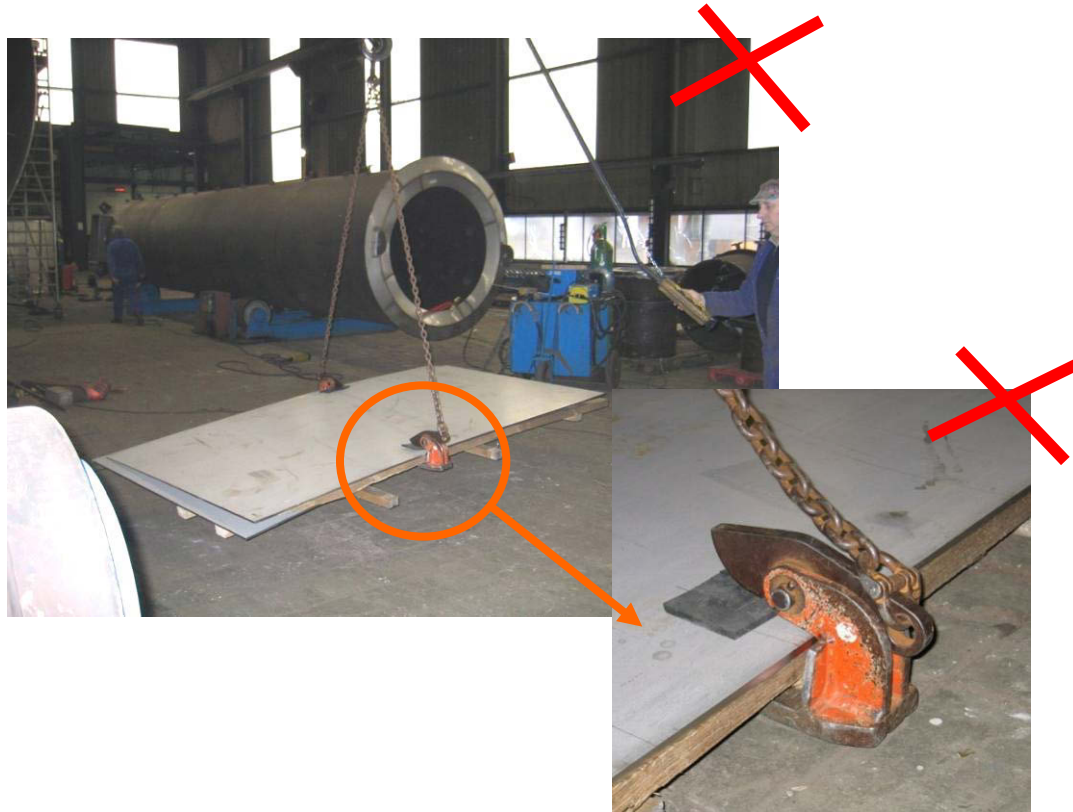



Masterlink too small.

Lifting angle exceeded
15° for IP10

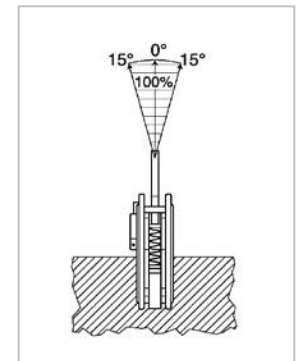

IP10

No latch in the chain hooks.

Crane hooks tip loaded used as lifting equipment.

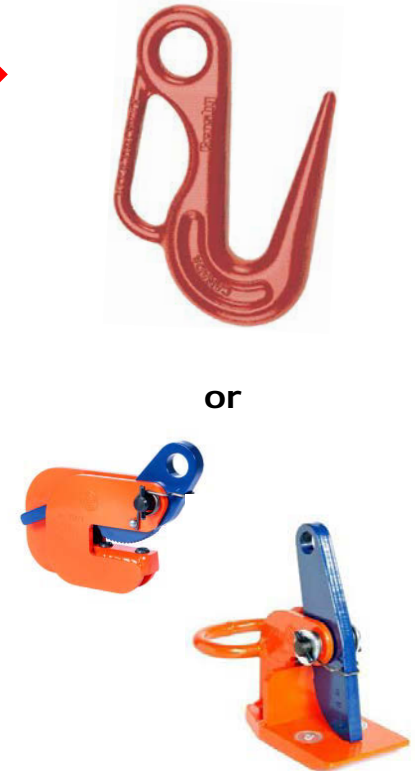

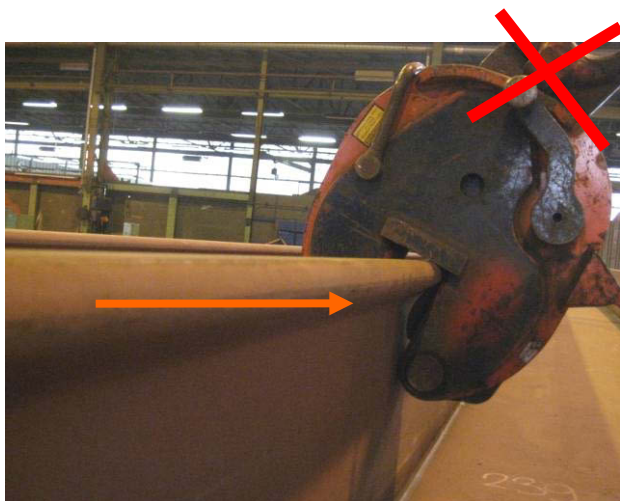

Do not use standard IPU10 or IP10 clamps for lifting bulb profiles. The pivot and camsegment do not have full contact to the material.

Clamp especially designed for handling bulb profiles: IPSBU(U)Z or IPU10 with larger jaw openings.

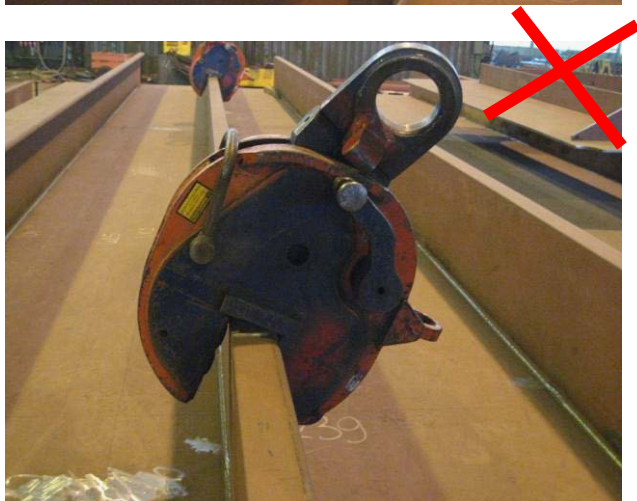

IPSBUUZ



Check all material before lifting !



- **Plate surface & clamp** ; free of dirt and dry
- **Hardness material** ; know the surface hardness of the material
- **Point of gravity** ; where is it located ?
- **Division of load** ; divide proportionally
- **Weight** ; min. load 10% of WLL clamp
- **Temperature** ; between -40° C (-40° F) and +100°C (+212° F)

Warning: To avoid serious personal injury read instructions before using!

Stocking of clamps

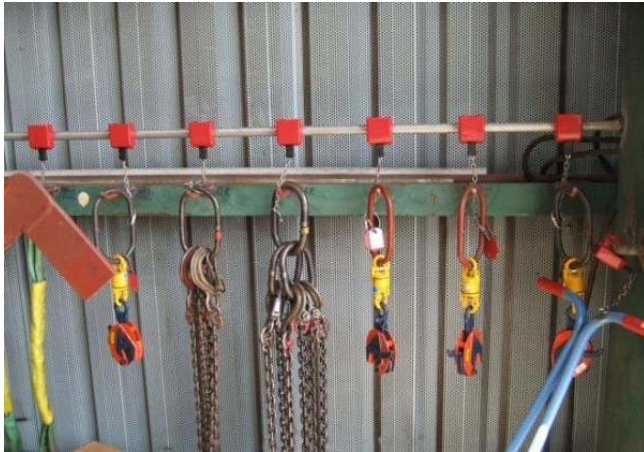

By **stocking** clamps in **closed position** the pivot and camsegment are touched and can be damaged without even using it! This causes **extra** and **unnecessary damage**.

Always stock clamps with the latch in open-position!
(avoid contact of camsegment and pivot)



Industry education & Technical support

Sales training

- Extensive product training
- Designed to extend the knowledge of the product range and application areas of CrosbyIP lifting clamps

User training

- Using the right clamp, in the right way, at the right place
- Employees are informed about proper lifting methods

Repair training

- Designed for inspection and periodic maintenance of CrosbyIP clamps.
- This certificate (valid for 4 years) qualifies Service Engineers to perform periodic maintenance- and repair services within organisation





MORE INFORMATION:

www.crosbyip.com

www.thecrosbygroup.com

